

# ANAFI™

— T H E R M A L —

USER GUIDE v6.7.0.1

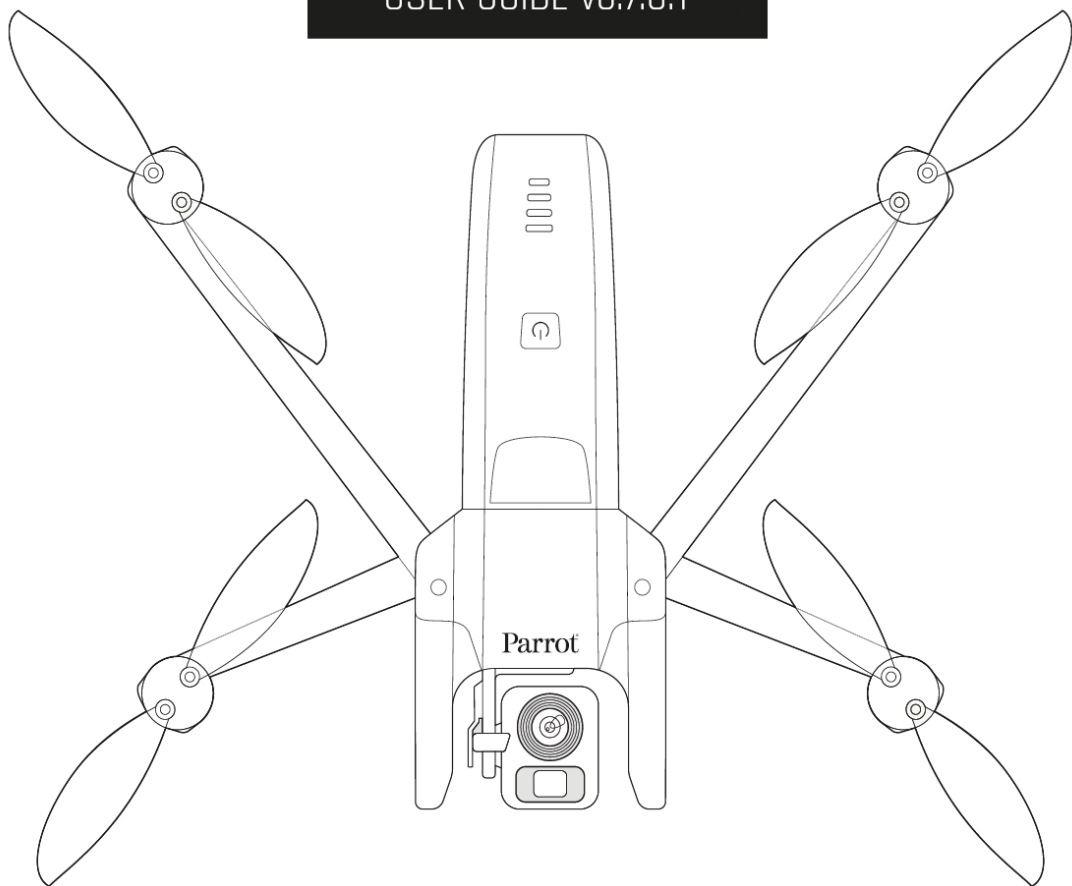

Parrot

EVERYDAY LIFE.ELEVATED



## WE ARE PARROT. WELCOME TO THE TEAM!

With **ANAFI Thermal**, you have chosen the finest, quietest, and most portable flying 4K HDR and thermography camera, you can use everywhere on the go, anytime.

We strongly recommend you read the following information and instructions thoroughly before you get **ANAFI Thermal** in the air, to make the most of your first 26-minute flight.

The indispensable prerequisites, on the next pages, will not occupy more than 5 minutes of your time: **ANAFI Thermal** requires the FreeFlight 6 v6.5 (or a more recent release) app to fly, and to make sure your drone and controller are fully up-to-date with the latest features.

As you discover the world of possibilities that **ANAFI Thermal** opens to you, you will fully understand the importance of mission planning in your workflow.

Have a great read, and many productive hours flying **ANAFI Thermal**.

## USING THIS GUIDE

- **Read entirely at least once:** it answers most questions that most users encounter when they discover **ANAFI Thermal**.
- **Keep it for reference and stay alert for updates:** they will be advertised on all Parrot websites and social media.
- **The Table of contents, on page 7, is active.** Click a title to access the corresponding section.
- **This online user guide has no index:** use [ctrl]-F (Windows) or [command]-F (Mac) to browse all occurrences of any keyword (*flight, preferences, gimbal, thermography, photo, EV, ISO*, and so on).

## PREREQUISITES

You want ANAFI Thermal up in the air as soon as possible, so do we. Refer to the enclosed Super Quick Start Guide (SQSG) if you need illustrated guidance to get these quick prerequisites out of the way.

1. **Wake your ANAFI Thermal's smart battery up.** Charge the battery using the enclosed USB-A to USB-C cable and a USB-A power adapter. The battery's LEDs start flashing; it is awake. Let it charge while you read. **Parrot recommends you always run a full charge of your smart battery before flying ANAFI Thermal.**
2. **Download FreeFlight 6 on your iOS or Android smartphone:** ANAFI Thermal requires **FreeFlight 6 to fly.** The app will enable you to update your **Parrot Skycontroller 3** and **ANAFI Thermal** when you power them on for the first time.



*Android FreeFlight 6 QR code*



*iOS FreeFlight 6 QR code*

When you have downloaded and installed **FreeFlight 6**, unfold the central arm of **Parrot Skycontroller 3** to power it on.

Use your device's USB cable to connect it to **Parrot Skycontroller 3** USB-A port, and install it on the device holder, as shown in the enclosed SQSG.

A prompt appears on your screen, which invites you to allow the communication between your device and the controller.

Tap "Allow" (iOS) or "OK" (Android); **FreeFlight 6** runs. After your device displays the app's splash screen, you get to **FreeFlight 6** homepage.

If the prompt does not appear on your screen when you connect your device to your *Parrot Skycontroller 3*, launch *FreeFlight 6* manually, as any other app.

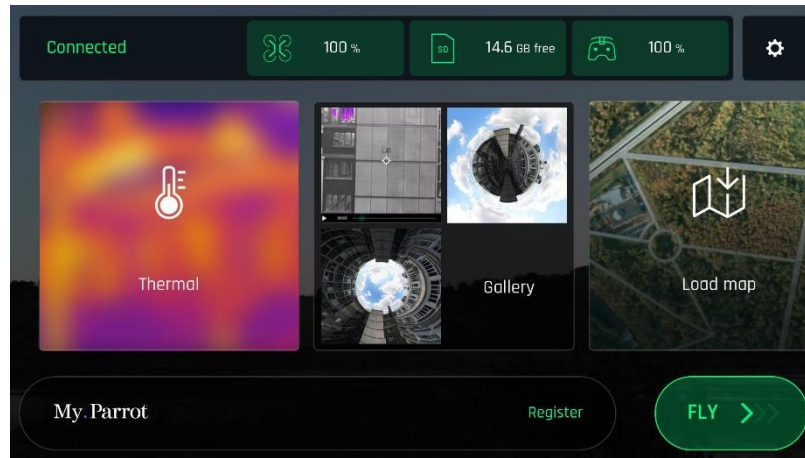

*iOS FreeFlight 6 homepage*

3. Tap the green “FLY” box on the homepage of **FreeFlight 6** to launch the initial updates. **FreeFlight 6** automatically updates the **Parrot Skycontroller 3** first, and **ANAFI Thermal** second.
4. **Parrot Skycontroller 3 update**: tap the green “CONTINUE” box to proceed. **FreeFlight 6** displays an animation and a progress circle on a screen labelled “Preparing your controller”. When the update is finished, the screen displays “Your controller is ready”. Tap “CONTINUE” to access the update of **ANAFI Thermal** (screenshots below are Android).

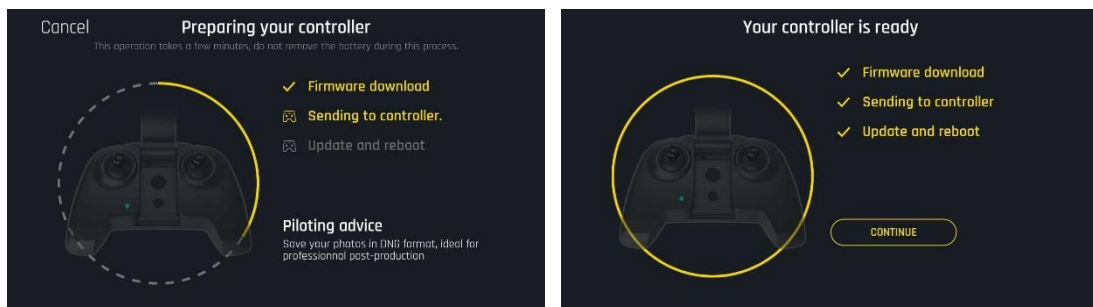

5. **ANAFI Thermal update: tap the green “CONTINUE” box to proceed.** FreeFlight 6 displays an animation and a progress circle on a screen labelled “Preparing your drone”. When the update is finished, the screen displays “Your drone is ready” and a “CONTINUE” box. Tap this “CONTINUE” box to come back to **FreeFlight 6** homepage (screenshots below are iOS).

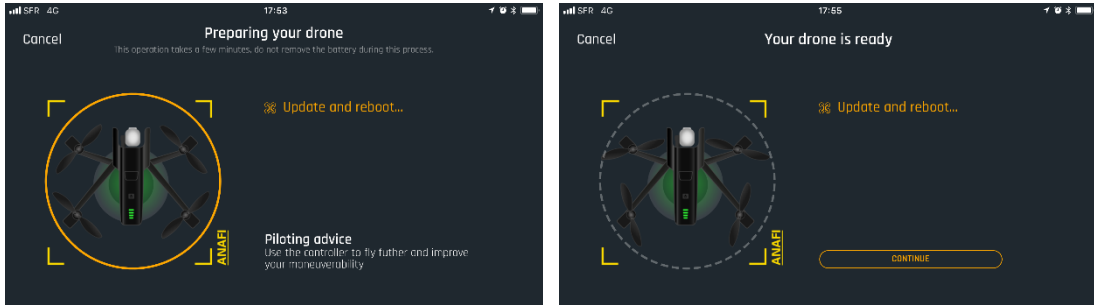

6. All systems are ready for flight.

## TABLE OF CONTENTS

|  |    |
|--|----|
| WE ARE PARROT. WELCOME TO THE TEAM!.....               | 3  |
| USING THIS GUIDE.....                                  | 3  |
| PREREQUISITES.....                                     | 4  |
| TABLE OF CONTENTS.....                                 | 7  |
| FOREWORD.....  | 11 |
| About ANAFI Thermal.....                               | 11 |
| About lens cap and camera calibration.....             | 11 |
| About Wi-Fi.....                                       | 11 |
| About GPS.....   | 11 |
| About 4K video formats.....                            | 11 |
| About the smart battery.....                           | 12 |
| About auto-RTH (return home).....                      | 12 |
| About devices.....                                     | 12 |
| About My.Parrot accounts.....                          | 12 |
| DISCLAIMER.....  | 13 |
| TECHNICAL SPECIFICATIONS.....                          | 14 |
| PACKAGE CONTENTS.....                                  | 15 |
| PRESENTATION OF ANAFI THERMAL.....                     | 16 |
| Ready to store or carry.....                           | 16 |
| Ready to fly.....                                      | 16 |
| PRESENTATION OF PARROT SKYCONTROLLER 3.....            | 17 |
| Ready to store or carry.....                           | 17 |
| Ready to pilot.....                                    | 17 |
| Camera and gimbal controls.....                        | 18 |
| LED status indicator color codes.....                  | 18 |
| Pairing ANAFI Thermal to a Parrot Skycontroller 3..... | 18 |
| PRE-FLIGHT CHECKLIST.....                              | 20 |
| Equipment.....   | 20 |
| Regulations.....                                       | 20 |
| Flight conditions.....                                 | 20 |

|  |    |
|--|----|
| GETTING STARTED.....                                   | 21 |
| TAKING OFF .....                                       | 22 |
| Ground take-off.....                                   | 22 |
| Hand launch.....                                       | 22 |
| FLYING.....  | 23 |
| RETURNING HOME .....                                   | 24 |
| Precise Home Setting.....                              | 24 |
| SMART RTH.....   | 24 |
| ADVANCED RTH SETTINGS.....                             | 25 |
| Pilot RTH .....  | 25 |
| Custom RTH .....                                       | 26 |
| LANDING .....  | 28 |
| Hand landing.....                                      | 28 |
| SMART LIPO BATTERY.....                                | 29 |
| Battery removal .....                                  | 29 |
| Battery installation .....                             | 30 |
| Battery charging .....                                 | 30 |
| Battery update.....                                    | 31 |
| Battery care and safety.....                           | 32 |
| MEDIA RETRIEVAL .....                                  | 33 |
| Extracting the microSD card .....                      | 33 |
| Retrieving photos and videos .....                     | 33 |
| Installing the microSD card.....                       | 33 |
| Compatible microSD cards.....                          | 34 |
| Direct media retrieval (drone to computer) .....       | 34 |
| FreeFlight 6 Gallery .....                             | 34 |
| MicroSD card formatting.....                           | 35 |
| INTRODUCING FREEFLIGHT 6.....                          | 36 |
| Presentation of the IOS HUD (video mode view).....     | 37 |
| Presentation of the Android HUD (photo mode view)..... | 39 |



|  |    |
|--|----|
| PREFERENCES.....   | 40 |
| Controls .....   | 40 |
| Presets.....   | 40 |
| Thermal.....   | 41 |
| Interface .....  | 42 |
| Safety.....  | 42 |
| Camera .....   | 43 |
| Network .....  | 43 |
| VISIBLE SPECTRUM VIDEOS AND PHOTOS .....                           | 44 |
| Making videos .....  | 44 |
| Taking photos.....   | 46 |
| Creating Panoramas.....  | 49 |
| GIMBAL TILT AND ZOOM CONTROLS.....                                 | 53 |
| Gimbal tilt control.....   | 53 |
| Zoom control.....  | 53 |
| Camera Calibration: Correct horizon (exceptional procedure) .....  | 56 |
| Camera Calibration: Gimbal calibration .....                       | 58 |
| Camera Calibration: Cameras alignment (exceptional procedure)..... | 58 |
| PRO-IMAGING SETTINGS .....   | 60 |
| Exposure value (EV) .....  | 60 |
| Shutter speed (s) .....  | 60 |
| ISO value (ISO) .....  | 61 |
| White balance (WB).....  | 61 |
| HDR.....   | 63 |
| NATURAL Style .....  | 63 |
| P-LOG Style.....   | 63 |
| INTENSE Style .....  | 63 |
| PASTEL Style.....  | 64 |
| ADJUSTMENT.....  | 64 |
| Lock AE .....  | 65 |
| Lock AE Touch.....   | 66 |

|   |    |
|---|----|
| THERMAL IMAGING.....                            | 67 |
| About Thermal Imaging .....                     | 67 |
| Presentation of the Thermal HUD .....           | 67 |
| Relative Thermal mode.....                      | 68 |
| Spot Thermal mode.....                          | 70 |
| Absolute Thermal mode.....                      | 71 |
| THERMAL ANALYZER MODE (DISPLAY OR REPLAY) ..... | 73 |
| CINESHOTS (VISIBLE SPECTRUM ONLY).....          | 76 |
| 360° .....                                      | 76 |
| Reveal .....                                    | 76 |
| Spiral .....                                    | 77 |
| Epic.....                                       | 77 |
| PILOTING MODES.....                             | 78 |
| Manual flight.....                              | 78 |
| Cameraman (visible spectrum only).....          | 78 |
| Follow Me (visible spectrum only) .....         | 79 |
| Smartdronies (visible spectrum only).....       | 81 |
| FPV (visible spectrum only).....                | 81 |
| MAP-BASED FLYING MODES.....                     | 82 |
| Flight Plan.....                                | 82 |
| Touch & Fly: Waypoint .....                     | 88 |
| Touch & Fly: POI.....                           | 88 |
| APPENDIX 1: TROUBLESHOOTING GUIDE .....         | 90 |
| APPENDIX 2: OPERATIONAL CHECKLIST.....          | 94 |

## FOREWORD

### About ANAFI Thermal

ANAFI Thermal was designed and optimized to fly as is. Parrot therefore strongly discourages the use of any add-on or accessory which could be mounted on, or attached to ANAFI Thermal (motor covers, feet extensions, buoys, hulls, etc.). In addition to the overweight they carry for the drone and its motors, they can indeed magnetically disturb ANAFI Thermal and impair its communications.

### About lens cap and camera calibration

**Always remove ANAFI Thermal's lens cap before you power the drone on.** The calibration of the camera cannot be achieved with the lens cap on, and furthermore, leaving the lens cap on the camera for the calibration can damage the mechanism of the gimbal.

### About Wi-Fi

Parrot asks you to switch off your smartphone's Wi-Fi connection when flying ANAFI Thermal with both the Parrot Skycontroller 3 and your phone: with this configuration, the drone and the controller communicate through ANAFI Thermal's Wi-Fi network and activating your phone's Wi-Fi can only result in interferences.

Therefore, your phone's Wi-Fi should **only** be activated – and connected to ANAFI Thermal's Wi-Fi network – when you want to fly the drone using your smartphone as its sole controller.

### About GPS

ANAFI Thermal does not need a satellite – GPS, Glonass, Galileo – synchronization (or fix) to take off. It can therefore be piloted indoor and through cluttered areas, stabilized by its onboard sensors.

However, automated and assisted flight modes require both ANAFI Thermal and the FreeFlight 6 device (preferably associated with the Parrot Skycontroller 3) synchronization to geocoordinate satellites – the Parrot Skycontroller 3 alone has no geo-positioning capacity.

For this reason, Parrot recommends ANAFI Thermal pilots to always set up, start and finish their automated and assisted flights from wide open areas, as a sports field.

### About 4K video formats

4K video formats are professional grade media which may not be read natively by slower computers. Shoot in 1080p or use a video converter to turn your ANAFI Thermal's 4K videos into a more manageable format (like 1080p) if they do not read properly on your equipment. This is especially true for Parrot's 4K Cinema format, which can only be handled by professional editing equipment.

### About the smart battery

ANAFI Thermal's smart battery is preinstalled on your drone. Always install it the same way and never attempt to install it upside down as it could expose your battery and your drone to **irrecoverable electrical damage**. As you will find out by reading this guide, ANAFI Thermal's battery is smart enough to enter a wintering mode when you are not using it for ten days in a row. This also means you need to wake it up and charge it completely before you fly ANAFI Thermal for the first time.

### About auto-RTH (return home)

By design, when synchronized to GPS and Glonass satellites and when short on power, ANAFI Thermal will always attempt to come back to its most recent take-off point, at minimal height over this take-off point, which is configurable through **FreeFlight 6** (between 20 meters and 100 meters) and is set by default at 30 meters.

For this reason, Parrot recommends ANAFI Thermal pilots to take extra care when moving away from the take-off location of their drone (for example to follow ANAFI Thermal). In such cases, pilots must cancel the auto-RTH from the orange 1-minute alert which appears on the screen of their device, and keep piloting ANAFI Thermal while monitoring closely its battery level, until it runs out of power and lands.

### About devices

In the following pages, the word "*device*" refers to the smartphone or tablet, either iOS or Android-based, on which **FreeFlight 6** is installed.

### About My.Parrot accounts

Parrot strongly recommends that you use your My.Parrot account (or create one if ANAFI Thermal is your first Parrot drone) to let Parrot store your ANAFI Thermal flight data. Sharing your data, even anonymously, benefits the community, as it enables us to improve our products. It also directly benefits all identifiable users in case they need to contact Parrot support teams.

## DISCLAIMER

1. **ANAFI Thermal** IS NOT A TOY and should not be used or handled by a person under the age of 18 years.
2. BEFORE USING **ANAFI Thermal**:
  - (A) CAREFULLY READ the user manual and all information and documentation available on [www.parrot.com](http://www.parrot.com), which is susceptible to be updated at any time and without prior notice (hereinafter referred to as "Parrot Documentation"). SPECIAL ATTENTION must be given to the paragraphs marked with the symbol  ;
  - (B) ENSURE YOU ARE AWARE OF THE REGULATIONS APPLICABLE TO THE USE OF DRONES AND THEIR ACCESSORIES (hereinafter referred to as "Applicable Regulations");
  - (C) REMEMBER that **ANAFI Thermal** may expose others and yourself to EQUIPMENT DAMAGE, PERSONAL INJURY, OR BOTH, which could result in serious harm or death.
3. Be aware that videos and photos that are promoted and advertised by Parrot Drones SAS and its affiliates have been made by and with experienced professionals and drone pilots. IN CASE OF DOUBT RELATING TO THE USE OF YOUR **ANAFI Thermal** DRONE AND ITS ACCESSORIES, ALWAYS REFER TO THE MOST RECENT VERSION OF THE PARROT DOCUMENTATION.
4. TO THE EXTENT PERMITTED BY APPLICABLE LAW, PARROT DRONES SAS, ITS SUBSIDIARIES, AND THEIR RESPECTIVE DISTRIBUTORS AND RETAILERS SHALL NOT BE LIABLE FOR ANY DAMAGES ARISING FROM, OR IN CONNECTION WITH THE NON-COMPLIANCE OF PARROT WITH THE DOCUMENTATION OR THE APPLICABLE REGULATIONS BY YOURSELF OR ANY PERSON USING YOUR **ANAFI Thermal**.

## TECHNICAL SPECIFICATIONS

### DRONE

- Size folded: 218x69x64mm
- Size unfolded (propellers unfolded): 242x315x64mm
- Weight: 315g
- Max transmission range: 4km with Parrot Skycontroller 3
- Max flight time: 25min
- Max speed: 55km/h
- Max vertical speed: 4m/s
- Max wind resistance: 50km/h
- Service ceiling: 4.500m above sea level
- Operating temperature: -10°C to 40°C

### SENSORS:

- GNSS: GPS + GLONASS
- Barometer and magnetometer
- Vertical camera and ultra-sound sensor
- 2x6-axis IMU
- 2x3-axis accelerometers
- 2x3-axis gyroscopes

### CONTROLLER

- Size folded: 94x152x72mm
- Size unfolded: 153x152x116mm
- Weight: 386g
- Transmission system: Wi-Fi 802.11a/b/g/n
- Operating frequencies: 2.4GHz - 5.8GHz
- Max transmission range: 4km
- Live streaming resolution: 720p (HD) 1280x720
- Battery capacity: 2,500mAh 3.6V
- Supported mobile devices:
  - Without tablet holder: screen size up to 6.2"
  - With tablet holder: screen size up to 10"
- USB ports: USB-C (charge), USB-A (connection)

### RGB CAMERA

- Sensor: CMOS 1/2.4", 21MP
- LD-ASPH lens:
  - Aperture: f/2.4
  - Focal length: 26mm (equivalent 35mm)
  - Depth of field: 1.5m to infinity
- Video format: MP4 (H264)
- Video resolution:
  - 4K Cinema (4096x2160 24fps)
  - 4K UHD (3840x2160 24/25/30fps)
  - FHD (1920x1080 24/25/30/48/50/60fps)
  - HD (1280x720 96/100/120fps)
- Video HFOV: 69°
- HDR: 4K UHD, 2.7K and 1080p videos, JPEG photos
- Digital zoom:
  - Lossless: up to x2.8 (FHD), up to x1.9 (2.7K), up to x1.4 (4K UHD)
  - Standard: up to 3x (all resolutions)

- Photo formats: JPEG, DNG (RAW)
- Photo modes: single, burst, bracketing, timer, panorama, timelapse and GPS lapse
- Photo resolution:
  - Wide: 21MP (5344x4016) / 4:3 / 84° HFOV
  - Rectilinear: 12MP (4000x3000) / 4:3 / 75.5° HFOV
- Shutter speed: 1 to 1/10000s
- ISO: 100 to 3200
- EV compensation: [-3, +3]
- Max video bitrate: 100Mbps

### IMAGE STABILIZATION

- 3-axis hybrid stabilization:
  - Mechanical: 2-axis (roll & pitch)
  - Electronic (EIS): 3-axis (roll, pitch & yaw)
- Controllable tilt range: -90° to +90° (nadir to zenith)

### THERMAL CAMERA

- Sensor: microbolometer FLIR Lepton® 3.5 (radiometric)
- Resolution: 160x120
- HFOV: 57°
- Pixel pitch: 12µm
- Spectral band: 8-14µm
- Photo format: JPEG
- Photo resolution: 3264x2448 (4/3)
- Photo modes: Single / Timelapse / GPS Lapse
- Video format: MP4 (H264)
- Video recording resolution: 1440x1080, 9fps
- Precision: ±5% max. (High-gain) or ±10% max. (Low-gain)
- Scene Dynamic Range: -10° à +140°C (High-gain) or -10° à +400°C (Low-gain)
- Video: MP4

### SMART BATTERY

- Type: LiPo 2S
- Capacity: 2700mAh
- Voltage: 7.6V
- Weight: 124 g
- Temperature range: -20°C / 60°C
- Charging time: 1h15
- Max charging power: 26.1W (3A \* 8.7V)

### CHARGER

- Power: 52 W
- Input AC: 100-240 V, 50-60 Hz, 1.5A (Max)
- Output:
  - 4x USB: DC 5V/6.8A (each 2.4A Max)
  - USB quick charge 3.0: DC 3.6V-6.5V/3A, 6.5V-9V/2A, 9V-12V/1.5A
- Energy efficiency: Level VI
- Dimensions: 95x28.8x61mm
- Weight: 200g
- AC Power Cords: US, EU, UK

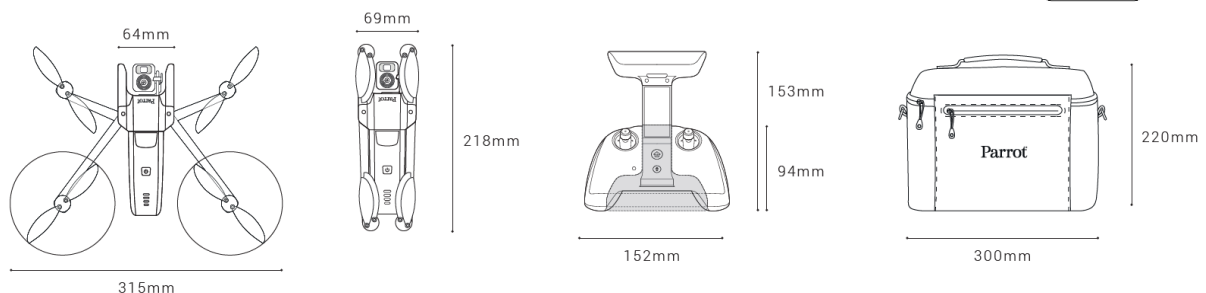
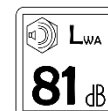

## PACKAGE CONTENTS

Your **ANAFI Thermal** package contains:

- an **ANAFI Thermal** drone
- 3 smart batteries, one of which preinstalled on **ANAFI Thermal**
- a shoulder bag
- a lens cap, preinstalled on the gimbal
- 4 USB-A to USB-C charging cables
- A multi-port USB charger
- a 16GB microSD card, preinstalled in **ANAFI Thermal**
- a microSD to SD card adapter
- a **Parrot Skycontroller 3**
- a tablet holder
- 8 spare propeller blades
- a mounting tool
- a Flight Safety Guide
- a Super Quick Start Guide (SQSG)
- a Wi-Fi settings card



## PRESENTATION OF ANAFI THERMAL

Ready to store or carry

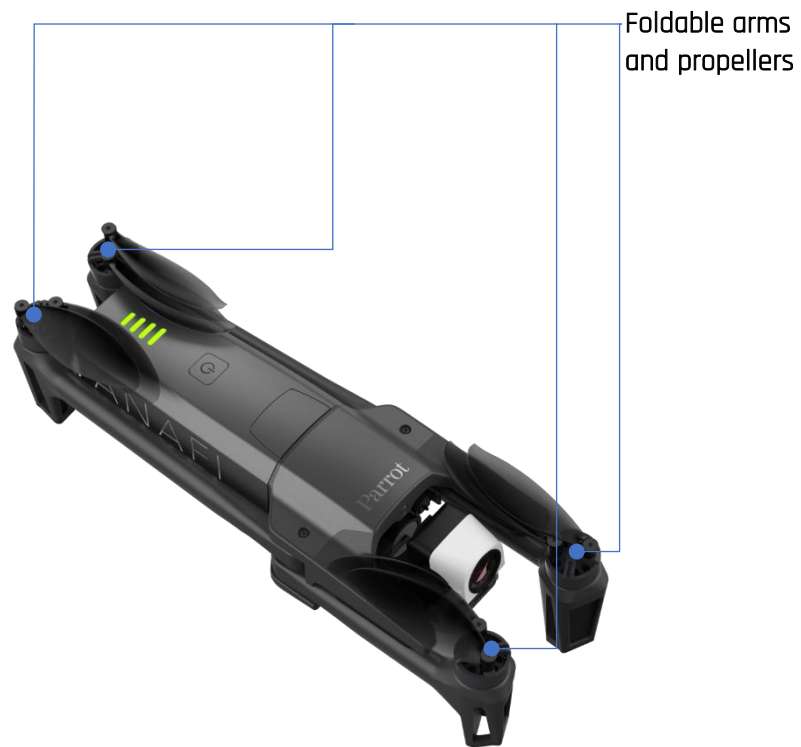

Ready to fly

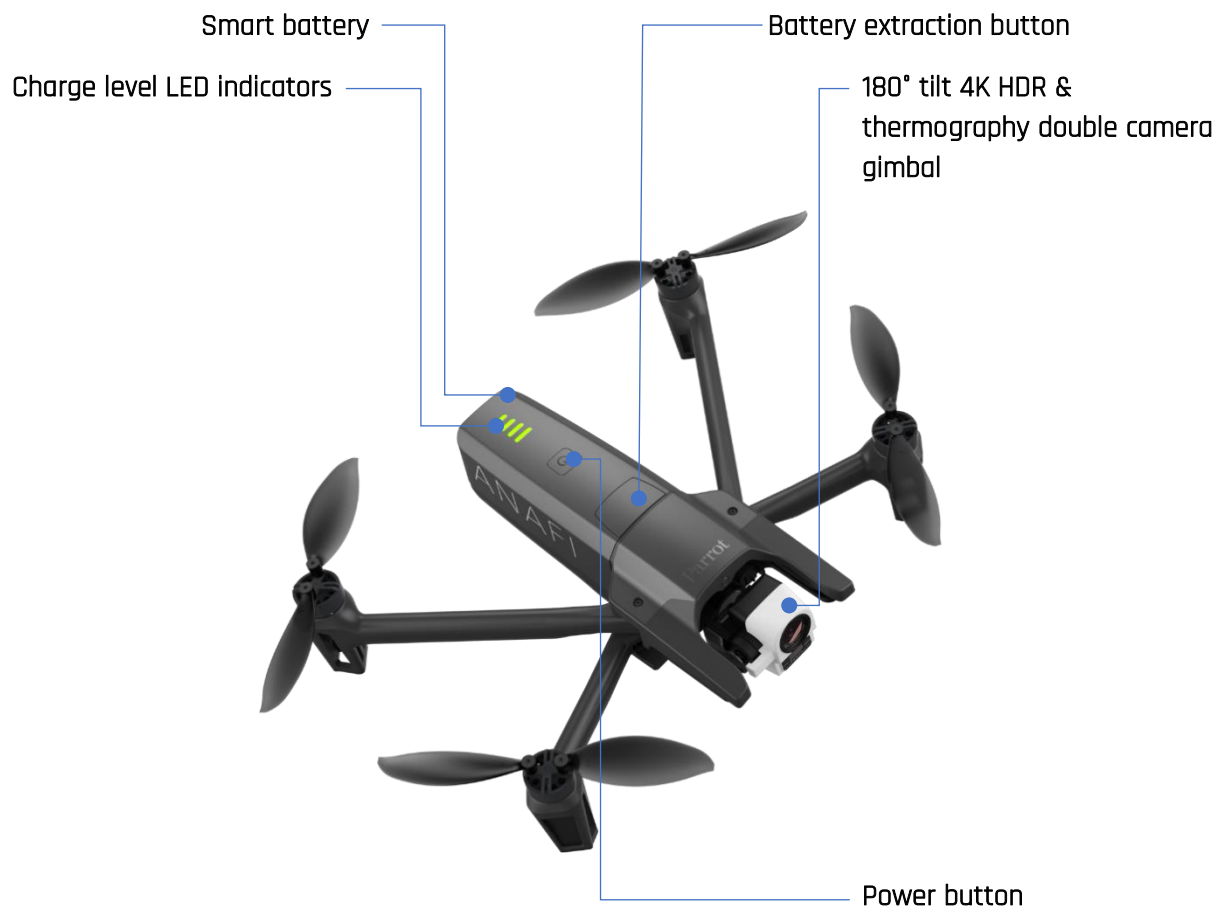



# PRESENTATION OF PARROT SKYCONTROLLER 3

Ready to store or carry



Ready to pilot



## Camera and gimbal controls

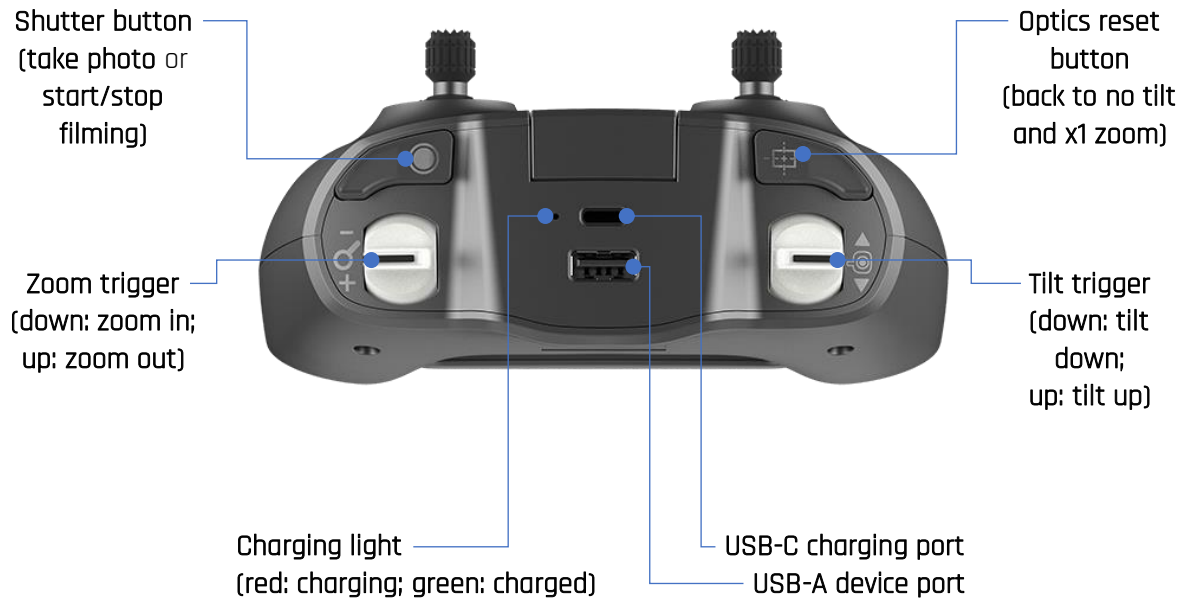

## LED status indicator color codes

When the **Parrot Skycontroller 3** is powered on, its LED status indicator gives you an instant visual indication:

- |   |   |
|---|---|
| - flashing green:                       | <b>Skycontroller 3</b> update in progress;  |
| - alternating light blue and dark blue: | connecting to <b>ANAFI Thermal</b> ;  |
| - flashing light blue:                  | no drone configured or wrong WPA key;   |
| - steady dark blue:                     | connected to <b>ANAFI Thermal</b> ;   |
| - alternating purple and dark blue:     | autonomous flight in progress;  |
| - alternating red and any other color:  | low battery alert ( <b>ANAFI Thermal</b> ,<br><b>Skycontroller 3</b> , or both) or RTH alert. |

## Pairing ANAFI Thermal to a Parrot Skycontroller 3

This procedure is useful to pair a drone and a controller which have never been paired, and to restore the lost pairing between a drone and a controller.

1. Check a compatible microSD card is inserted into **ANAFI Thermal**.
2. Power **ANAFI Thermal** on.
3. Open the **Parrot Skycontroller 3** to power it on.
4. Plug the drone and the controller together with an USB-A (controller) to USB-C (drone) cable.
5. The LED of the **Parrot Skycontroller 3** flashes briefly in green: it is acknowledging **ANAFI Thermal**.

6. Wait for synchronization between **Parrot Skycontroller 3** and **ANAFI Thermal** (steady dark blue LED on the controller); check that the left trigger of the **Parrot Skycontroller 3** activates the drone's gimbal to ensure the synch is complete.
7. Unplug the controller from the drone.

## PRE-FLIGHT CHECKLIST

### Equipment

- ⚠ Make sure you have downloaded the latest version of FreeFlight 6 and that both your Parrot Skycontroller 3 and your **ANAFI Thermal** have been updated with the latest versions of firmware.
- ⚠ For the ultimate **ANAFI Thermal** experience, make sure you have the right USB-A cable to connect your Parrot Skycontroller 3 and your device.
- ⚠ Make sure **ANAFI Thermal** is fitted with a microSD card with enough free memory space.
- ⚠ Make sure all four foldable arms of **ANAFI Thermal** are unfolded.
- ⚠ Make sure its propellers are clean, intact and unobstructed.
- ⚠ Make sure both **ANAFI Thermal's** and **Parrot Skycontroller 3's** batteries are fully charged.
- ⚠ Make sure **ANAFI Thermal's** battery is securely installed on the drone's body.
- ⚠ Make sure the lens cap has been removed from **ANAFI Thermal's** gimbal.
- ⚠ Make sure **ANAFI Thermal's** lenses are clean - if you need to clean them, hold the gimbal between two fingers so that you do not pressure its mechanism when you clean the lenses, and gently wipe the lenses with a microfiber cloth.

### Regulations

- ⚠ Make sure the use of **ANAFI Thermal** is allowed where you are intending to fly.
- ⚠ Check for potential restrictions regarding the use of Wi-Fi frequencies in the area where you are intending to fly.

### Flight conditions

- ⚠ Check that your flying zone is safe and clear.
- ⚠ Do not fly **ANAFI Thermal** at night.
- ⚠ Do not fly **ANAFI Thermal** over urban areas or over restricted airspaces such as airports, train stations, power plants, national reserves, and so on.
- ⚠ Check the weather: do not fly **ANAFI Thermal** in the rain, fog, snow, or in a wind exceeding 14 meters per second or 50 km/h.
- ⚠ **Due to the operating mode of its vertical camera and ultrasound sensor, Parrot recommends you do not fly ANAFI Thermal over water and other reflective surfaces (mirrors, glass, and so on).**

## GETTING STARTED

1. Charge the battery using the enclosed USB-A to USB-C cable and a USB-A power adapter. Charging times depend on the supply capacity of the adapter. Refer to the *"Battery charging"* section of this guide for additional information. **Parrot recommends you always run a full charge of your smart battery before flying ANAFI Thermal.**
2. If you want to use the controller and enjoy the full **ANAFI Thermal** experience, charge **Parrot Skycontroller 3**.
3. Check that your flying zone is safe and clear.
4. To start the drone, place it on a flat horizontal surface and press the power button.
5. **a) If you use Parrot Skycontroller 3**, unfold the central part of the controller to power it on, wait for the steady dark blue light, then plug your device to the controller using a USB cable. **Parrot recommends you always fly ANAFI Thermal with Parrot Skycontroller 3 and a device, for the best flight experience.**  
**b) If you do not wish to use the controller**, connect your device to the Wi-Fi network of **ANAFI Thermal**, using the Wi-Fi settings card located inside the drone's shoulder bag - SSID format: AnafiThermal-xxxxx.
6. **FreeFlight 6** runs automatically on your device and connects to **ANAFI Thermal** and to **Parrot Skycontroller 3**.
7. Check for controller and drone software updates.
8. Calibrate your **ANAFI Thermal**, your **Parrot Skycontroller 3**, or both, if required, following the instructions on the screen of your device.
9. Check that your flying zone is still safe and clear, and that no one (people, animal) has approached or is approaching **ANAFI Thermal**.
10. Stay at least 2m (6ft) clear from the drone, press the  button and enjoy the flight!

## TAKING OFF

### Ground take-off

Position **ANAFI Thermal** on a flat, even, and clear surface.

Power it on, move at least 2m (6ft) away from **ANAFI Thermal** and check that the surroundings of the drone are absolutely clear.

Press the  button on your **Parrot Skycontroller 3**, or tap the green "TAKE-OFF" box, on the screen of your device.

**ANAFI Thermal** takes off and stabilizes at 1m (3ft) from the ground, waiting for commands from the pilot.

### Hand launch

- ⚠ **Be especially careful when you hand launch ANAFI Thermal. This procedure is safe provided you are not distracted or startled by an outside event with a live drone in your hand: concentrate on what you are doing, but always stay aware of your surroundings.** Upon first opening of **FreeFlight 6**, from version 6.2, a hand launch tutorial reminds you the following procedure. You can activate hand launch from this tutorial page.

You can also activate the hand launch option from the "Interface" menu of **FreeFlight 6** "PREFERENCES" (refer to the "PREFERENCES - Interface" section of this guide for further information).

Power **ANAFI Thermal** on and position the drone on your flat, open hand. On the screen of your device, the green "TAKE-OFF" box is replaced by a blue "HAND LAUNCH" box.

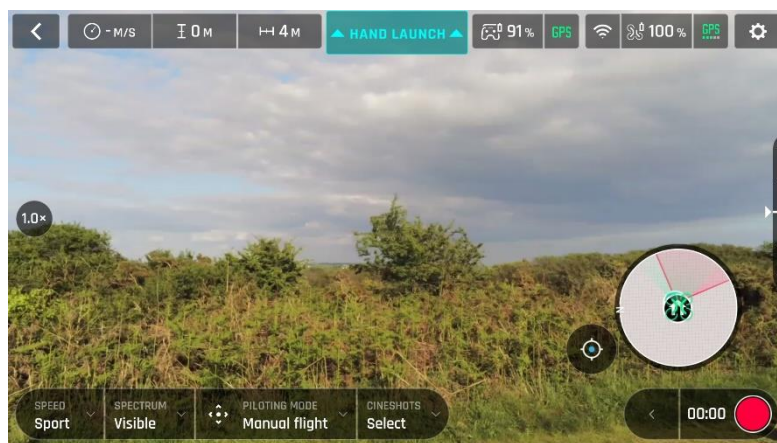

















*Android "Hand Launch" Screen*

Press the  button on your **Parrot Skycontroller 3**, or tap the blue "HAND LAUNCH" box on the screen of your device. The drone's blades start rotating slowly and the screen of your device displays a hand-launch animation.

**Briefly and briskly lift ANAFI Thermal up and forward with your open hand:** the drone is airborne. It stabilizes, waiting for commands from the pilot.



## FLYING

| Left control stick (default mode)  | Right control stick (default mode)   |
|--|--|
| <br><br>Rise           | <br><br>Forward                |
| <br><br>Descend        | <br><br>Reverse                |
| <br><br>Turn right | <br><br>Move to the right |
| <br><br>Turn left  | <br><br>Move to the left  |

⚠ Note that you can modify **ANAFI Thermal's** controls through the PREFERENCES menu of **FreeFlight 6**. Refer to the "*PREFERENCES / Controls*" section of this guide for additional information.

⚠ As any drone of the **ANAFI** series, **ANAFI Thermal's** controls can also be set in Arcade mode. Refer to the latest general **ANAFI** user guide for additional information on Arcade mode control.

## RETURNING HOME

To bring **ANAFI Thermal** back to its take-off position, press the  button on your **Parrot Skycontroller 3**, or tap the  icon on the screen of your device.

**ANAFI Thermal** rises to 30 meters over its take-off point – or to the altitude you have set, through **FreeFlight 6**, between 20 and 100 meters – and flies back over its take-off position.

Refer to the “*PREFERENCES - Safety*” section of this guide for instructions on RTH height configuration.

In the Follow Me mode, when the  button or icon is activated, **ANAFI Thermal** flies back to the position of the pilot.

### Precise Home Setting

When flight conditions are optimal at take-off, **ANAFI Thermal** can set a “precise home” for itself, through its vertical camera. In that case, a pop-up on the screen of **FreeFlight 6** confirms a precise home has been set, and the home icon of the mini-map turns green.

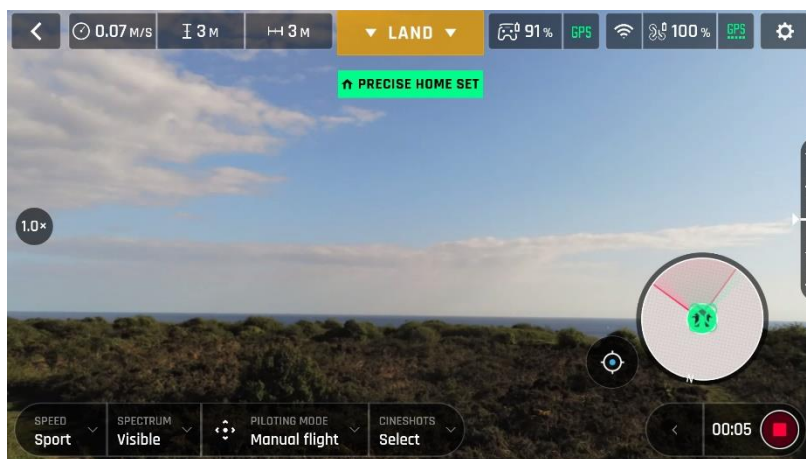

*Android “Precise Home Set” pop-up*

### SMART RTH

**ANAFI Thermal** features a Smart RTH capability: considering its altitude and its distance from its take-off point, the drone computes in real time the power it needs to return home – or to the pilot, or to a custom location (refer to the “*PREFERENCES / Safety / Advanced RTH settings*” of this guide for additional details on this feature)

If you feel confident you can bring **ANAFI Thermal** back to its take-off point or if you wish to land it at a different location, you can cancel the auto-RTH directly from the alert pop-up.



## ADVANCED RTH SETTINGS

Activate advanced RTH settings through the Safety Preferences of **FreeFlight 6** (refer to the “*PREFERENCES – Safety*” section of this guide for further information).

There are two advanced RTH options: Pilot & Custom.

- ⚠ *By activating advanced RTH features, if you select return to Pilot or Custom position, the drone might not be able to reach its destination in case of low battery. Parrot will not be held responsible in case the drone lands in a different location.*

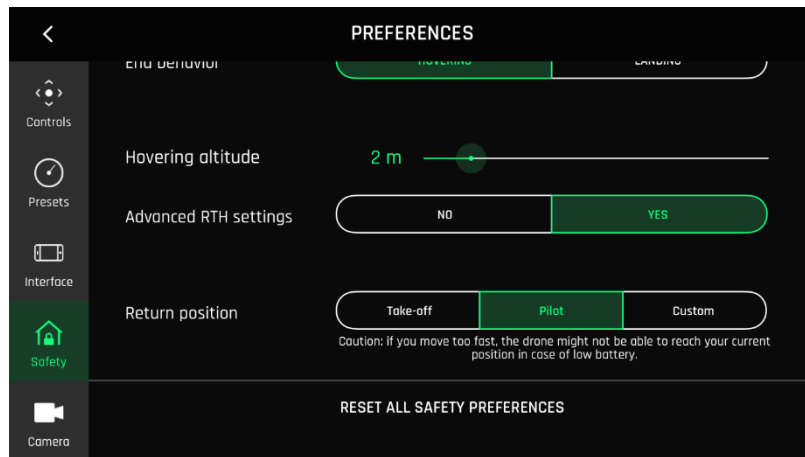

*Advanced RTH settings activated (iOS)*

### Pilot RTH

When the “Pilot” advanced RTH option is selected, **ANAFI Thermal** comes back to the GPS position of the device used to control the drone (whether linked to a **Parrot Skycontroller 3** or not) at the exact moment an RTH button is activated – or to the last known coordinates of the device, in case it has lost GPS synch.

For this reason, we recommend ANAFI Thermal pilots not to move, after they have activated an RTH button, when in “Pilot” advanced RTH mode.

- ⚠ **Note that when the Smart auto-RTH function is activated in “Pilot” advanced RTH mode, ANAFI Thermal comes back to the GPS position of the device, at the moment of the activation of the auto-RTH function – or to the last know coordinates of the device, in case it has lost GPS synch.**

## Custom RTH

By default, when you have set up **ANAFI Thermal** for a flight, provided it has a GPS synch, when you activate the “Custom” advanced RTH option, the current latitude and longitude of the drone appears in the “Custom point” field, like in the screen capture below.

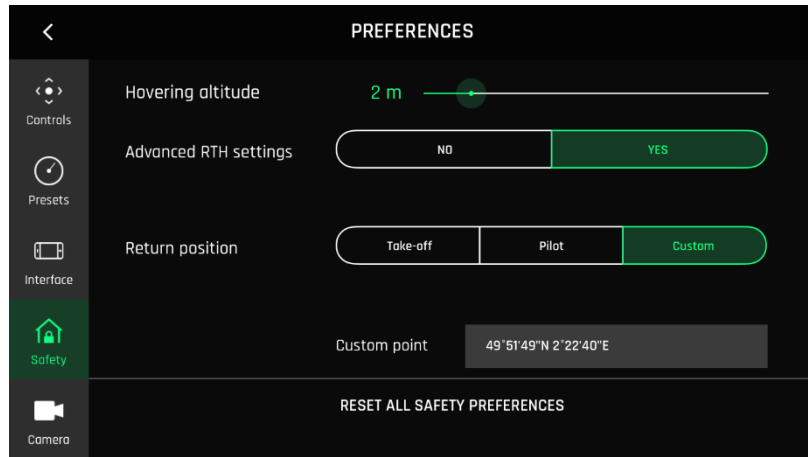

*Custom RTH option activated*

To change this custom point, leave the Preferences back to the HUD (“<” top left), then access the map of **FreeFlight 6**: tap the mini map in the lower right part of the screen.

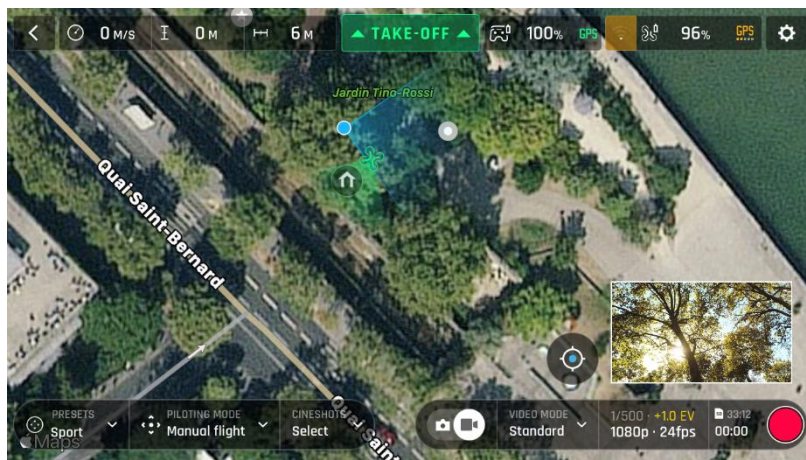

*Initial home, close to drone icon*

The “Home” icon appears close to the drone icon - or exactly over the drone icon if the 1<sup>st</sup> GPS fix at power up was excellent. Here, the GPS synch could still be improved, as shown by the orange GPS icon in the drone box of the top bar. The blue dot materializes the position of the controller - typically that of the pilot.

Press the "Home" icon to activate it, then drag and drop it to your desired RTH point.

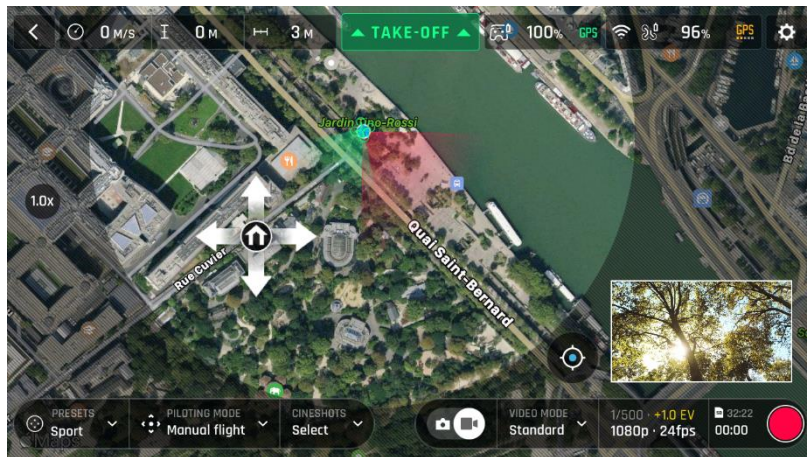

*Drag-and-dropping the "Home" icon (iOS)*

In our example, we have set up for a flight at a corner of a park, and planned an RTH over an open area, close to the center of the same park.

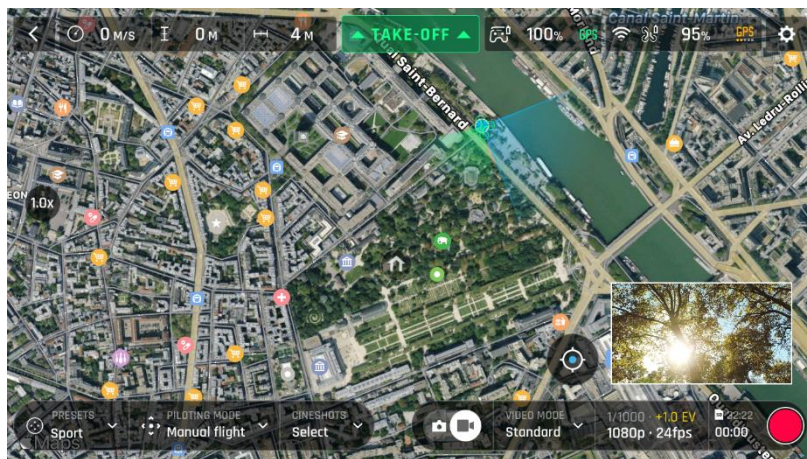

*Custom "Home" set (iOS)*

Access Safety Preferences again and note the Custom point coordinates have been updated. You are set!

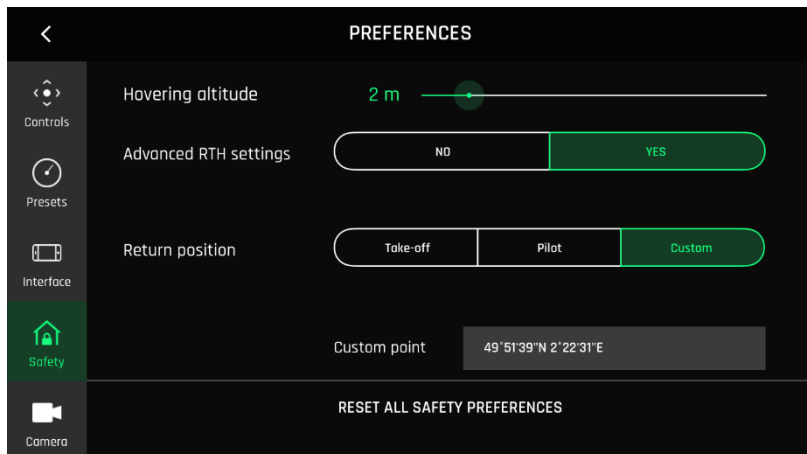

*Updated Custom point coordinates (iOS)*

## LANDING

Fly **ANAFI Thermal** directly over a flat, even, and clear surface, then press the  button, or tap the orange “LAND” box on the screen of your device.

**ANAFI Thermal** lands.

### Hand landing

- ⚠ Be especially careful when you hand land **ANAFI Thermal**. This procedure is safe provided you are not distracted or startled by an outside event with a live drone approaching your hand: concentrate on what you are doing, but always stay aware of your surroundings.

Fly **ANAFI Thermal** at least 50 cm directly over your open hand then press the  button, or tap the orange “LAND” box on the screen of your device.

**ANAFI Thermal** lands on your hand.

## SMART LIPO BATTERY

ANAFI Thermal's smart LiPo battery is preinstalled on the drone and should always be reinstalled in the same way, with the LEDs and power button facing up, to avoid irrecoverable electric damage to the battery, to the drone, or to both.

The smart battery can be charged whether it is installed on ANAFI Thermal, or not. However, you will need to remove the battery from the drone to access your microSD card. Refer to the *"Retrieving media"* section of this guide for further information.

- ⚠ When handling ANAFI Thermal, you should never apply pressure and generally avoid touching the drone's camera and gimbal – its most sensitive parts. The following directions will help you handle your drone and battery safely.

### Battery removal

To remove the smart battery from the drone, unfold the back arms of ANAFI Thermal. Set the drone on a flat and even surface (such as a table), and press the push-button which connects the battery to the body of the drone with your thumb. Gently slide your thumb and the battery toward the back of ANAFI Thermal. When the hook of the push-button is disengaged from the body of the drone, lift the battery away from ANAFI Thermal.



*ANAFI Thermal: battery removal*

## Battery installation

To install the smart battery back on the drone, unfold the back arms of **ANAFI Thermal**. Set the drone on a flat and even surface (such as a table), and position the battery's three hooks into the drone's corresponding slots. Place your middle finger on the Parrot logo of **ANAFI Thermal** and your thumb on the back of the smart battery. Squeeze your fingers together until you feel and hear the battery clicking into the body of the drone. You are set!



*ANAFI Thermal: battery installation*

## Battery charging

To charge **ANAFI Thermal's** smart LiPo battery, use the enclosed USB-A to USB-C cable to plug the battery to a power source. This convenient cable enables you to charge your battery from:

- a wall socket, through an AC adapter;
- a tabletop or laptop computer's USB-A port;
- a power bank's USB-A port.

Indicative **full charging times** depending on power sources are as follows (at 20°C):

- AC adapter (5V - 3A): between 150 and 210 minutes;
- a computer's or power bank's USB-A port: between 270 and 320 minutes.

**ANAFI Thermal's** smart battery can also be recharged through a Power Delivery adapter or charger (USB-PD standard), using a USB-C to USB-C cable (not included in the box). In that configuration, full charging time of the battery can be reduced to 105 minutes.

- ⚠ **About USB-PD power banks:** Parrot does not recommend **ANAFI Thermal** users to invest in a **USB-PD power bank**, as not all of them support USB-C to USB-C charging of **ANAFI Thermal's** battery. Indeed, due to the nature of the USB-C technology, some USB-PD power banks recharge on **ANAFI Thermal's** smart battery, rather than the other way around.



When **ANAFI Thermal's** smart LiPo battery is plugged to a power source and charging, **its 4 LEDs indicate in real time its level of charge:**

- LED 1 flashing: battery is between 0 and 25% charged;
- LED 1 steady & LED 2 flashing: battery is between 25 and 50% charged;
- LEDs 1 and 2 steady & LED 3 flashing: battery is between 50 and 75% charged;
- LEDs 1, 2 and 3 steady & LED 4 flashing: battery is between 75 and 100% charged;
- battery is plugged and all LEDs are off: battery is full.

Similarly, when **your battery is not installed on ANAFI Thermal**, you can check its charge level at any time by pressing its power button:

- 1 steady LED lights up: battery is between 0 and 25% charged;
- 2 steady LEDs light up: battery is between 25 and 50% charged;
- 3 steady LEDs light up: battery is between 50 and 75% charged;
- 4 steady LEDs light up: battery is between 75 and 100% charged.

Finally, the same logic applies when **the smart LiPo battery is installed on the drone and when ANAFI Thermal is powered on**. The number of steady LEDs enables you to estimate your remaining flying time:

- 1 steady LED is lit up: less than 6 minutes flying time remaining;
- 2 steady LEDs are lit up: between 6 and 12 minutes flying time remaining;
- 3 steady LEDs are lit up: between 12 and 18 minutes flying time remaining;
- 4 steady LEDs are lit up: between 18 and 25 minutes flying time remaining.

## Battery update

**ANAFI Thermal** smart batteries can be updated, like the drone itself, its controller and its controlling software **FreeFlight 6**. When a battery update is available with a **FreeFlight 6** release, the following message appears in the app.

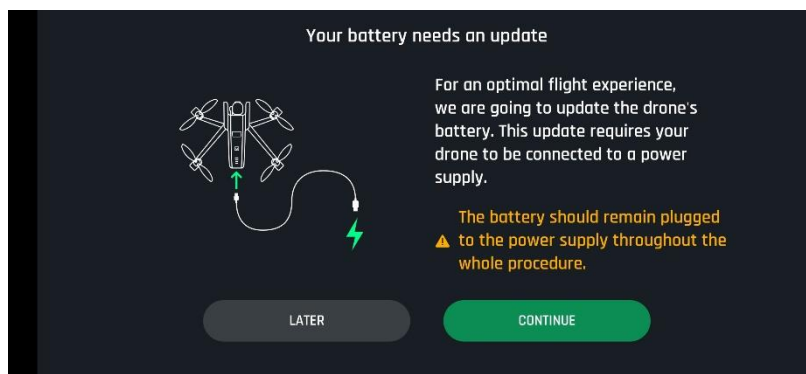

*Battery update, Android*

Follow the simple in-app instructions to update your battery.

- ⚠ **Remember to keep your battery plugged to a power supply throughout the procedure and repeat it with all your batteries.**

## Battery care and safety

As you can see, ANAFI Thermal's smart LiPo battery is as high-tech as any other element of your flying 4K HDR camera.

Its firmware can be updated, like that of the drone and that of the controller, and it even features a wintering mode, designed to increase its durability and facilitate its care. Ideally, when not in use for a prolonged period, batteries should be stored half-charged. When not in use for 10 days, ANAFI Thermal's smart battery discharges itself, if required, to 65% charge, over a 48h period. In other words, after a maximum of 12 days without use, this smart battery enters hibernation with a charge level which never exceeds 65%. If you leave your ANAFI Thermal battery for 12 days, you will find out its power button does not activate the charge level LED indicators. **The battery needs to be charged to exit the wintering mode and start operating as described in the earlier paragraphs: this behavior preserves the battery over time. Parrot recommends you always run a full charge of your smart battery before flying ANAFI Thermal.**

Like all other LiPo batteries, ANAFI Thermal's smart battery must be handled, transported and stored with care:

- never leave a battery unattended while charging;
- never expose a battery to extreme temperatures, neither hot, nor cold;
- never charge a battery which is still warm from use (wait for at least 20 minutes);
- never use or recharge a damaged or swollen battery;
- always store your battery in a dry, ventilated place, at a temperature close to 20°C;
- always carry your battery in a fire-retardant bag or case (unless it is installed on **ANAFI Thermal**: it can then be transported with the drone, inside its carrying case).

Finally, note that ANAFI Thermal's smart battery will only allow charge in ambient temperatures between +10°C and +45°C, and that using ANAFI Thermal in temperatures approaching 0°C will reduce its flying time. To minimize this slight drop in the smart battery's capacity, keep your battery as warm as possible before starting a flight in a cold environment.

- ⚠ If the behavior of your battery is not consistent with the elements contained in this section, and if you cannot get it to power your ANAFI Thermal, you must hard reset your battery: plug it to a power source with the enclosed cable, then keep the battery's power button pressed for 15 seconds (regardless of the behavior of the LEDs), and release the button.

The battery's LEDs flash quickly, one after the other, alternating green and red: the hard reset is successful!



## MEDIA RETRIEVAL

Your ANAFI Thermal is equipped with a 16GB microSD card which enables you to record videos and photos, and to transfer them easily to your computer, your device, or both. This section explains how to extract the microSD card from ANAFI Thermal, how to retrieve your media from the microSD card, and how to reinstall it in the drone.

### Extracting the microSD card

To extract the microSD card from ANAFI Thermal, the battery must be removed from the drone. Refer to the *"Battery removal"* section of this guide for details.

When you remove the battery from the body of the drone, you uncover the microSD slot, which is protected by a small metal lock.

**Slide this metal lock with a finger toward the back of ANAFI Thermal to open it** – you will feel a slight click. Lift the front part of the lock to open the slot. Reach the microSD card and extract it. An open lock icon and an arrow, located on the left of the microSD slot, confirm to you the way you must slide the lock to open it.

### Retrieving photos and videos

Use the enclosed microSD to SD card adapter to transfer videos and photos you have taken with ANAFI Thermal to your computer. Slide the microSD card into the adapter and use the adapter how you would use any other SD card: access your videos and photos through a card reader or the SD card slot of your computer. Copy your videos and photos to the hard drive of your computer to edit, store, and manage your media.

- ⚠ The enclosed 16GB microSD card enables you to record just over 20 minutes of 4K video. For this reason, Parrot recommends you backup your photos and videos, and you empty your 16GB microSD card after each flight, to ensure you always have available memory space to capture new still or moving images.

### Installing the microSD card

To install the microSD card back into its slot, open the metal lock as you did when you extracted the card from ANAFI Thermal. Position the microSD card into its keyed slot: make sure the metal contacts of the card are facing down and set on the contacts of the drone. The shortest side of the microSD card should be facing toward the back of the drone.

**Tilt the metal lock over the microSD card. Press a finger gently on the lock and slide it toward the front of ANAFI Thermal to close and lock it** – you will feel a slight click. A closed lock icon and an arrow, located on the right of the microSD slot, confirm to you the way you must slide the lock to close it.

## Compatible microSD cards

Refer to Parrot online documentation for an updated list of ANAFI Thermal compatible microSD cards.

## Direct media retrieval (drone to computer)

You can also retrieve your media directly from ANAFI Thermal, without extracting the microSD card.

Use the enclosed USB-A to USB-C cable to connect the drone (USB-C) to a USB-A port of your computer. Power **ANAFI Thermal** on.

**ANAFI Thermal** mounts as any other external drive: copy your media from the DCIM/100MEDIA directory to your computer's hard drive.

When you are done managing your media, eject **ANAFI Thermal** as any other external drive.

- ⚠ When plugged in to a computer and powered on, ANAFI Thermal's battery discharges itself. This means you must recharge your smart battery after you have retrieved your media, even if it was fully charged when you began the procedure.

## FreeFlight 6 Gallery

Finally, you can manage your media and download them directly from ANAFI Thermal to your device with the Gallery of FreeFlight 6.

The Gallery also lets you:

- preview visible and thermography videos, without downloading them to your device;
- create panoramas (refer to the "*Creating panoramas*" section of this guide for additional details);
- format microSD cards (refer to the following section of this guide for details);
- analyze thermography videos (refer to the "*Thermal analyzer - replay - mode*" of this guide for additional details).

To access the Gallery from the homepage of FreeFlight 6, either by tap the "microSD card" box, on the top bar of the interface, or tap the "Gallery" box, at the center of the interface.

If ANAFI Thermal is powered on and connected to the device (directly or through the Parrot Skycontroller 3), the FreeFlight 6 Gallery displays the microSD card media, by default.

Tap any media to preview it.

Tap any green media download box to transfer the corresponding media to your device.

Access the media you have downloaded to your device by tapping the “Local” box, at the top of the interface.

### MicroSD card formatting

Tap the “Format SD card” button of the SD Card screen of **FreeFlight 6** Gallery to access formatting options. Select one of the following options.

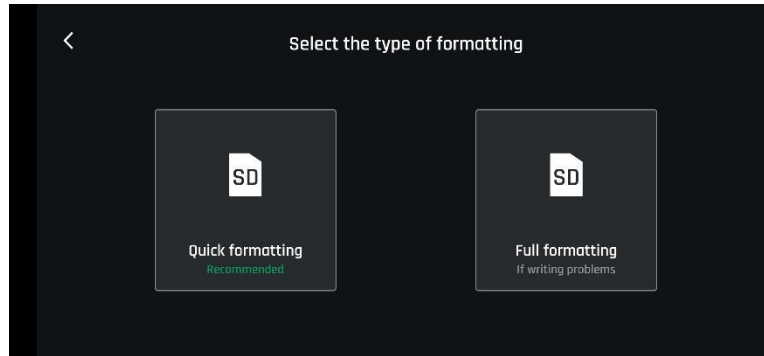

Confirm your selection from the next screen to launch the formatting.

Note that both options delete all microSD card contents, including flight data.

## INTRODUCING FREEFLIGHT 6

The HUD (head-up display) interface of FreeFlight 6 is the ultimate companion to ANAFI Thermal. It enables you to access all the outstanding features of ANAFI Thermal, from the screen of your device, at the touch of your thumbs.

This section explores FreeFlight 6 functions, starting with a presentation of the top and bottom bars of the Visible Spectrum HUD.

Access the Visible Spectrum HUD by taping "FLY" on the bottom right of the homepage of FreeFlight 6.

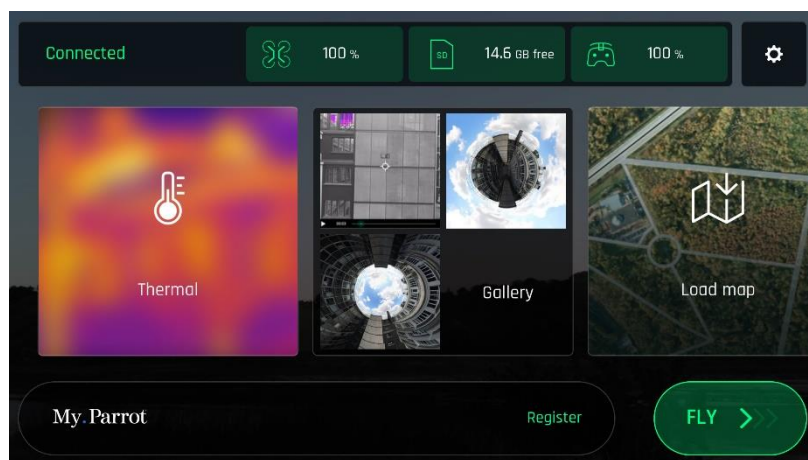

*iOS FreeFlight 6 homepage*

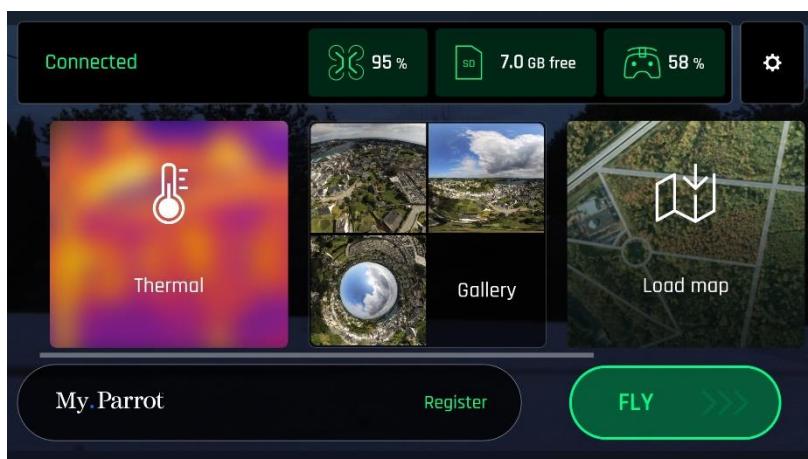

*Android FreeFlight 6 homepage*

## Presentation of the iOS HUD (video mode view)

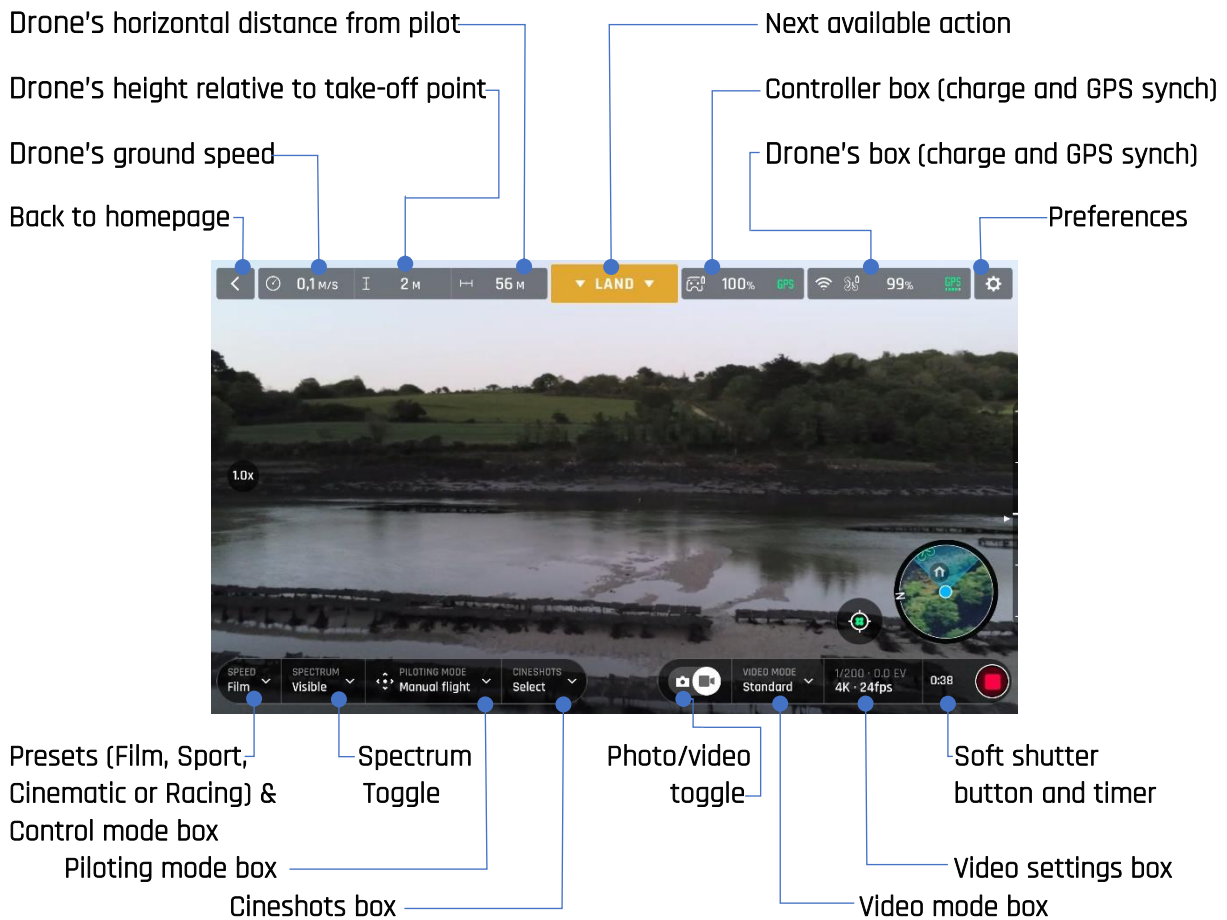

ANAFI Thermal and FreeFlight 6 are packed with features which are accessible from the HUD. Before we present the "PREFERENCES" menu of FreeFlight 6, here is an overview of your drone's current piloting, Cineshots, Dronies, and visible video modes.

|                        |                             |                     |                     |
|------------------------|-----------------------------|---------------------|---------------------|
| <b>Piloting modes:</b> | Manual flight               | <b>Cineshots:</b>   | 360° (left & right) |
|                        | Cameraman                   |                     | Reveal (30 & 60m)   |
|                        | Follow Me                   |                     | Spiral (30 & 60m)   |
|                        | Smartdronies                |                     | Epic (30 & 60m)     |
|                        | FPV                         |                     |                     |
|                        | Flight Plan                 | <b>Smartdronies</b> | Orbit               |
|                        | Touch & Fly: Waypoint & POI | &                   | Parabola            |
|                        |                             | <b>POI Dronies</b>  | Dolly Zoom          |
|                        |                             |                     | Boomerang           |
| <b>Video modes:</b>    | Standard                    | <b>Follow Me</b>    | Orbit               |
|                        | Cinema                      |                     | Parabola            |
|                        | Hyperlapse                  |                     | Tornado             |
|                        | High-Framerate              |                     | Boomerang           |
|                        | Slow Motion                 |                     |                     |

The Android HUD of **FreeFlight 6** displays strictly the same information, buttons, toggles, and menus as the iOS HUD, in the same way - despite slight cosmetic differences.

- ⚠ **Note that both GPS icons are green, on both screen captures (iOS and Android screen presentations). This means that the drone's controller (Skycontroller 3 or device) and ANAFI Thermal are both synchronized to enough GPS and Glonass satellites to optimize the stability of the drone, especially at higher altitudes.**

Parrot therefore recommends you always check both your FreeFlight 6 HUD's GPS icons are green (and not red), before you make your ANAFI Thermal take off.

## Presentation of the Android HUD (photo mode view)

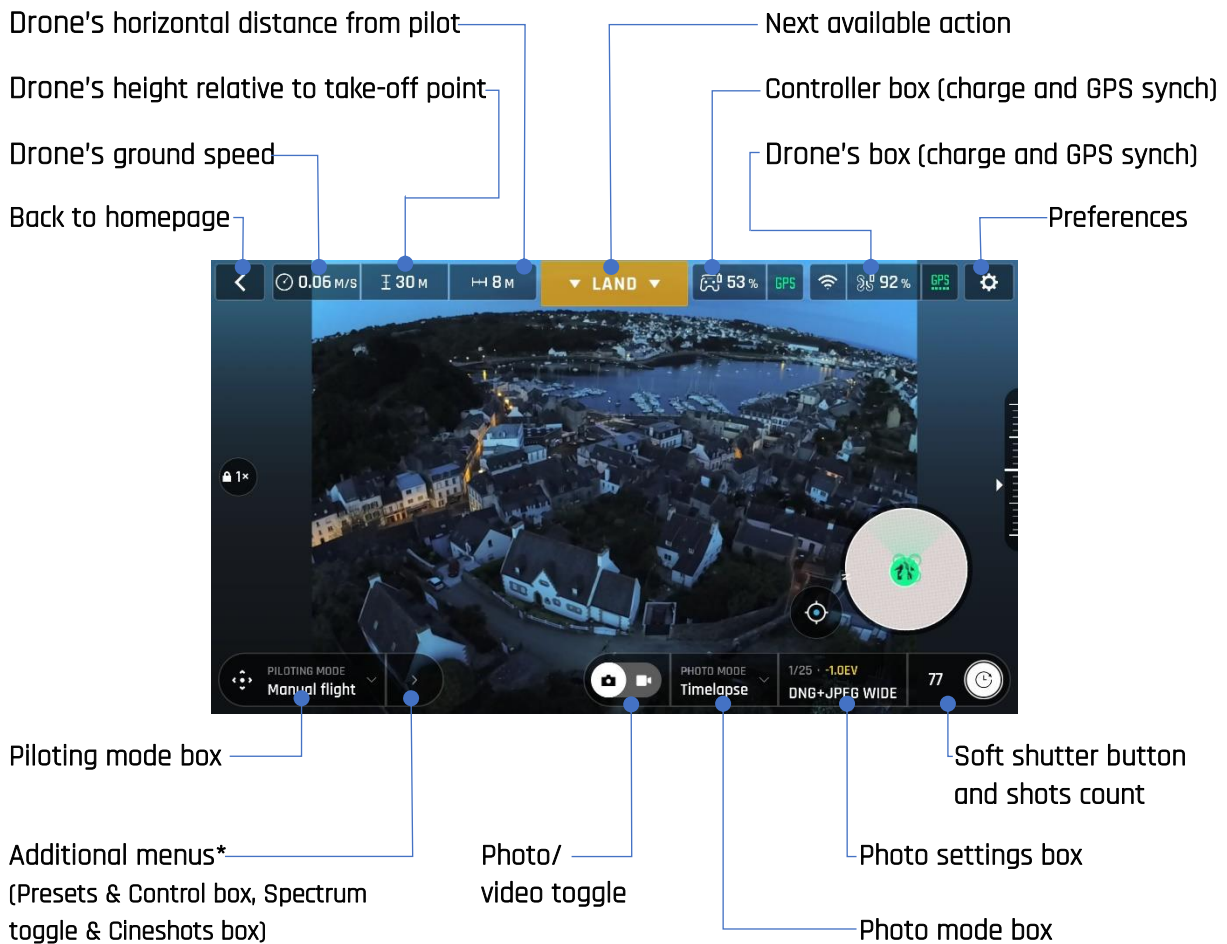

ANAFI Thermal's photo modes include a Single shot mode, a Burst mode, a Bracketing mode, a Timer mode, a five-format Panorama mode, a Timelapse mode and a GPS Lapse mode.

*\* Note that depending on the size of Android devices, some may directly display the same information as iOS devices, despite slight cosmetic differences.*

⚠ Note that both GPS icons are green, on both screen captures (iOS and Android screen presentations). This means that the drone's controller (Skycontroller 3 or device) and ANAFI Thermal are both synchronized to enough GPS and Glonass satellites to optimize the stability of the drone, especially at higher altitudes.

Parrot therefore recommends you always check both your FreeFlight 6 HUD's GPS icons are green (and not red), before you make your ANAFI Thermal take off.

## PREFERENCES

Access **FreeFlight 6** preferences through the icon on the extreme right of the top bar of the homepage, or that of the HUD. Preferences enable you to fine-tune **ANAFI Thermal** to your hand – to customize it, to fit your piloting and filming styles.

Access **Preferences** submenus from the boxes on the left of the screen. Tap a box to select it and access its items.

For all items, **default values (DV)** are marked in **bold characters**.

### Controls

The Controls preferences set the way your controller behaves. It also enables you to activate the “Hand-launch” option.

Tap an item option to select it.

- Control mode: **CLASSIC** / ARCADE (only available in flight)
- Inverse joys **OFF** (white) / ON (green)
- Special **OFF** (white) / ON (green)
- EV Trigger **OFF** (white) / ON (green)
- Hand-launch **NO** / **YES**

**About EV Trigger:** when activated, the EV Trigger enables you to control the EV (exposure value) directly from the zoom (right) trigger of the **Parrot Skycontroller 3**. (refer to the “*PARROT SKYCONTROLLER 3 PRESENTATION*” section of this guide for additional information). With this setting, you can therefore manually modify your EV from -3.0 to +3.0, by increments of 0.3, which automatically impacts the shutter speed (“s” value) of the camera.

Tap “RESET ALL CONTROL PREFERENCES” on the bottom of the page to reset preferences.

### Presets

The Presets preferences allow you to adapt the flight behavior of **ANAFI Thermal** for each of four modes (“Film”, “Sport”, “Cinematic” and “Racing”).

Tap an item option to select it.

- Global reactivity: 1% to 100% (DV: **15%** for **FILM & CINEMATIC**; **20%** for **SPORT**; **30%** for **RACING**)
- Horizon **FIXED** / **DYNAMIC** (DV: **FIXED** for **FILM & SPORT**; **DYNAMIC** for **CINEMATIC & RACING**)
- Camera tilt speed 1°/s to 180°/s (DV: **10°/s** for **FILM & CINEMATIC**; **20°/s** for **SPORT & RACING**)
- Banked turn **NO** / **YES** (DV: **YES** for **FILM, CINEMATIC & RACING**; **NO** for **SPORT**)
- Inclination 1°/s to 40°/s (DV: **10°/s** for **FILM**; **20°/s** for **CINEMATIC**; **25°/s** for **SPORT & RACING**)



- Vertical speed 0.1m/s to 4m/s (DV: **1m/s** for **FILM**; **2m/s** for **SPORT**; **2.5m/s** for **CINEMATIC**; **3m/s** for **RACING**)
- Rotation speed 3°/s to 200°/s (DV: **10°/s** for **FILM**; **20°/s** for **SPORT & CINEMATIC**; **40°/s** for **RACING**)

⚠ **Note that “Global reactivity”, “Inclination” and “Vertical speed” values are the ones which carry the biggest impact on ANAFI Thermal's acceleration and general flying behavior. Corresponding sliders turn to orange instead of green to warn users the settings they have selected require extreme care, superior piloting skills, or both, when flying ANAFI Thermal. Your drone will always remain outstandingly responsive, but with extreme settings, it will accelerate much more rapidly than you can imagine: you have been warned!**

Tap “RESET ALL PRESETS PREFERENCES” on the bottom of the page to reset the corresponding Mode to its default values. In other words, you must tap “RESET ALL PRESETS PREFERENCES” in each Mode to revert all Modes to their default values.

## Thermal

The **Thermal** preferences deal with specific thermography settings.

Tap an item option, use “<” or “>” and “+” or “-” to change values.

- Unit of temperature: FAHRENHEIT / KELVIN / **CELSIUS**
- Color gradient: **Fusion** / Rainbow / White Hot / Black Hot
- Thermal calibration **AUTO** / MANUAL
- Temperature range: **DEFAULT** / VERY HIGH TEMPERATURES
- Custom emissivity Emissivity (0.0 to 1.0; DV: **0.95**)  
Reflected temperature (-273° C to 1 000° C; DV: **20° C**)

**About Thermal calibration:** **AUTO** mode is recommended for most users. If you select the **MANUAL** mode, note that the application will periodically remind you to calibrate your thermal camera, through the dedicated  button of your HUD.

**About Temperature range:** **DEFAULT** (High-Gain) mode is recommended for scenes between - 10° C and 140° C. **VERY HIGH TEMPERATURES** (Low-Gain) mode is recommended for scenes between 140° C and 400° C.

**About Reference values:** adapt reference values to a specific target to improve the accuracy of your measurements.

- **Emissivity** refers to the ability of surfaces to emit thermal (infra-red) radiation. **Emissivity** values range from 0.0 to 1.0: the **emissivity** of highly polished metallic surfaces seldom exceeds 0.10; the **emissivity** of the surface of a perfect black body is 1.0.
- **Reflected temperature** refers to the thermal radiation originating from objects which reflect off the measurement target.

Tap "RESET THERMAL SETTINGS" on the bottom of the page to reset preferences. This button also reinitializes thermal Spot and Absolute scales to default values, as well as visible and thermal images blending.

## Interface

Interface preferences set the amount of information which appear on your **FreeFlight 6** HUD.

For most item, tap an option to select it – but tap "CHANGE" to access more FPV Goggles options.

- Show minimap                                 NEVER / WITH CONTROLLER / ALWAYS
- Map type   ROADMAD / SATELLITE / HYBRID
- Show framing grid                             NO / 3x3 / 6x6
- Measurement system                         **AUTO** / IMPERIAL / METRIC
- FPV Goggles                                    Tap "**CHANGE**" to access the following options:  
   Parrot - CockpitGlasses 1  
   Parrot - CockpitGlasses 2  
   **Parrot - CockpitGlasses 3**  
   Goggle - FPV  
   Google - Cardboard glasses  
   Tap "**TEST**" to verify the rendering of your selection

Tap "RESET ALL INTERFACE PREFERENCES" on the bottom of the page to reset preferences.

## Safety

Through Safety preferences, you can set a safe and clear flying area for **ANAFI Thermal**.

Set **ANAFI Thermal**'s maximum flight altitude with the "Max altitude" slider.

To set a maximum distance from the pilot for your drone, move the "Max distance" slider to the required value.

**When the Geofence is activated, ANAFI Thermal will automatically stop when it reaches the maximum altitude or the maximum distance you have selected: a red prompt will also appear on your HUD.**

- Geofence   NO / YES
- Max altitude   1m to 150m (DV: **30m**)
- Max distance   10m to 4 km (DV: **300m**)
- Minimum altitude when using RTH               20m to 100m (DV: **30m**)
- End behavior   **HOVERING** / LANDING
- Hovering altitude                                    1m to 10 m (DV: **2m**)
- Advanced RTH settings                             NO / YES

***Note: By activating advanced RTH features, if you select return to Pilot or Custom position, the drone might not be able to reach its destination in case of low battery. Parrot will not be held responsible in case the drone lands in a different location.***

Return position

TAKE-OFF / PILOT / CUSTOM

Tap "RESET ALL SAFETY PREFERENCES" on the bottom of the page to reset preferences.

## Camera

Camera preferences enable you to select camera options, both in photo and video modes.

- Camera calibration Tap "CALIBRATE" to access "Correct horizon", "Gimbal Calibration" & "Cameras alignment" features.
- Auto record from take-off NO/ **YES** (video only)
- Lossless zoom only **NO** / YES (selecting "YES" blocks zoom in JPEG RECT)
- Display overexposure **NO** / YES
- Anti-flickering OFF / **AUTO** / 50Hz / 60 Hz

**About Correct horizon:** only resort to the "Correct horizon" procedure if you notice your videos and photos are systematically tilted on the same side. Refer to the "*Camera calibration*" section of this guide for the detailed procedure.

**About Cameras alignment:** only resort to the "Cameras alignment" procedure if you notice the thermal and visible images of your **ANAFI Thermal** are misaligned. Refer to the "*Camera calibration*" section of this guide for the detailed procedure.

**About Overexposure display:** when this setting is activated, the HUD of **FreeFlight 6** shows all overexposed areas of the screen as hatched, which enables you to fine-tune your framing, your EV settings, or both.

**About Anti-flickering:** this setting and the associated technology aim at eliminating the flicker effect which can arise due to some artificial lights. The "AUTO" option should work for most users, but depending on your country, you can try other settings if you feel bothered by a flicker effect on your device's screen, your artificial light videos, or both.

Tap "RESET ALL CAMERA PREFERENCES AND SETTINGS" on the bottom of the page to reset preferences.

## Network

Network preferences let you change your **ANAFI Thermal**'s Wi-Fi network name, password, and band.

- Broadcast DRI **OFF** / ON
- Network's name Tap the field to change your **ANAFI Thermal**'s network name
- Password Tap the box to change your network's password
- Wi-Fi band **AUTO** / MANUAL

**About Direct Remote Identification (DRI):** the DRI system makes your drone locally broadcast information about itself for regulatory compliance (where applicable).

## VISIBLE SPECTRUM VIDEOS AND PHOTOS

In addition to its thermography camera, ANAFI Thermal is equipped with a state-of-the-art 4K, 3-axis-stabilized camera, which delivers astoundingly sharp motion and still pictures, through a 1/2.4" CMOS 21MP sensor.

The lens of this camera includes low dispersion aspherical elements, that reduce chromatic aberrations and flare, and guarantee optical excellence to such a small, smart and versatile airborne imaging system.

Although you can film and take pictures using your device as ANAFI Thermal's only controller, we recommend you always use the Parrot Skycontroller 3 and your device, for the best controlled, most precise, and safest filming and photos-shooting flights.

### Making videos

By default, ANAFI Thermal and FreeFlight 6 are set to start recording a video as soon as ANAFI Thermal takes off. This literally means all you have to do, to start filming, is to fly ANAFI Thermal into the sky.

However, depending on your filming objectives, ANAFI Thermal and FreeFlight 6 offer a wealth of settings, from full auto to manual professional options, for you to make the most of every situation.

If required, tap the photo/video toggle in the middle of the bottom bar of the HUD, to circle the film camera (right icon) in white.

Main filming options are twofold, and accessible from the HUD of FreeFlight 6.

- **First**, select a **video mode** by tapping the corresponding box of the HUD. The options appear on your device, as they do on the screen capture below. Tap a video mode to select it and tap the **video mode** box again to confirm your choice.
- **Second**, select a **video resolution and a framerate (fps – frames per second) value** from the corresponding box of the HUD. Tap the **video settings box** to call the individual **video resolution** and **fps** boxes. Tap the **video resolution box** to access the available video resolutions and tap one to select it. Tap the **fps box** to access the available fps values and tap one to select it. Tap the **video settings box** again to close the sub-boxes and confirm your choices.

Available video resolutions and fps values depend on the video mode you have selected:

|                          |   |
|--------------------------|---|
| <b>Standard:</b>         | all-round <b>4K, 2.7K</b> or <b>1080p</b> filming, at <b>24, 25</b> or <b>30fps</b> .   |
| <b>Cinema:</b>           | spectacular <b>4K cinema</b> filming, at <b>24fps</b> .   |
| <b>Hyperlapse:</b>       | time-lapse video with a configurable speed factor (x15, x30, x60, x120, x240), in <b>4K, 2.7K</b> or <b>1080p</b> , exported at <b>24, 25</b> or <b>30fps</b> . |
| <b>Slow-Motion 1080p</b> | filming at <b>48, 50</b> or <b>60fps</b> , automatically slowed down by a factor of 2 ( <b>x0.5</b> ) and exported at 24, 25 or 30fps.                          |
| <b>Slow-Motion 720p</b>  | filming at <b>96, 100</b> or <b>120fps</b> , automatically slowed down by a factor of 4 ( <b>x0.25</b> ) and exported at 24, 25 or 30fps.                       |
| <b>High-Framerate:</b>   | <b>1080p</b> filming at <b>48, 50</b> or <b>60fps</b> (ideal for post-processing) and <b>720p</b> filming at <b>96, 100</b> or <b>120fps</b> .                  |

In the following screen capture, **Standard video mode** is activated: available video resolutions are **4K (UHD), 2.7K** and **1080p (FHD)** – either in **24, 25** or **30fps**, which you would find out by tapping “30 fps” on the bottom right of the screen.



*iOS Standard video format menu*

When you are happy with your settings and your framing, press the hard shutter button on the right of **Parrot Skycontroller 3** (or tap the soft shutter button of the HUD) to start filming.

The soft shutter button of the HUD animates and displays a cycle between red square, and red circle. The timer starts running.

Press the hard shutter button of the controller (or tap the soft shutter button of the HUD) again to end the recording. The soft shutter button of the HUD comes back to steady, red and round. The timer resets.

## Taking photos

To access the photo camera of ANAFI Thermal, tap the photo/video toggle in the middle of the bottom bar of the HUD, to circle the photo camera (left icon) in white.

Seven photo modes are available on ANAFI Thermal: Single shot, Burst, Bracketing, Timer, Timelapse, GPS Lapse and Panorama (5 formats).

Thanks to its 21MP CMOS sensor, ANAFI Thermal produces three main picture formats:

- **rectilinear** (up to 16MP) or **wide** (21MP) **JPEG**;
- **wide 21MP DNG** (Digital NeGative: Adobe open standard RAW format);
- **composite panoramas** (JPEG), up to **32MP**.

Main photography options are accessible from the HUD of FreeFlight 6.

- **First**, select a **photo mode** by tapping the corresponding box of the HUD. The options appear on your device. Tap a photo mode to select it and tap the **photo mode** box again to confirm your choice.

When the **"Single"** mode is selected, the soft shutter button of the HUD appears as a full white circle.

When the **"Burst"** mode is selected, the soft shutter button of the HUD displays the Burst icon inside a white circle.

Selecting the **"Bracketing"** mode opens three options: 3 photos (-1 EV, +0.0 EV, +1 EV), 5 photos (-2 EV to +2 EV) and 7 photos (-3 EV to +3 EV). When one of these options has been selected, the soft shutter button of the HUD displays the Bracketing icon inside a white circle.

Selecting the **"Timer"** mode opens three options: 3 secs, 5 secs and 10 secs. When one of these options has been selected, the soft shutter button of the HUD displays "3 secs", "5 secs" or "10 secs" inside a white circle, depending on the option which has been chosen.

Selecting the **"Panorama"** mode opens three options: Vertical, Horizontal and 360. When one of these options has been selected, the soft shutter button of the HUD displays the corresponding icon inside a grey (ANAFI Thermal landed) or white (ANAFI Thermal flying) circle.

The Panorama mode is indeed the only photography mode which requires the drone to be flying before you can activate the shutter. Refer to the next section, *"Creating Panoramas"*, for additional details about the "Panorama" mode.

Selecting the **"Timelapse"** mode opens six options: 5 secs, 10 secs, 15 secs, 30 secs, 60 secs, and 120 secs. When one of these options has been selected, the soft shutter button of the HUD displays a Timelapse icon.

Selecting the “GPS Lapse” opens six options: 5m, 10m, 20m, 50m, 100m, and 200m. When one of these options has been selected, the soft shutter button of the HUD displays a GPS Lapse icon.

- **Second**, select a **photo format** from the corresponding box of the HUD. Tap the **photo settings** box to call the **photo settings** boxes. Tap the **last box on the right** of the screen to access the **available photo formats**.

Available photo formats for each photo mode are as follows:

Single: JPEG RECT, JPEG WIDE, DNG+JPEG (RECT or WIDE)

Burst: JPEG RECT, JPEG WIDE

Bracketing: JPEG RECT, JPEG WIDE, DNG+JPEG (RECT or WIDE)

Timer: JPEG RECT, JPEG WIDE, DNG+JPEG (RECT or WIDE)

Panorama: JPEG RECT only

Timelapse: JPEG RECT, JPEG WIDE, DNG+JPEG (RECT or WIDE)

GPS Lapse: JPEG RECT, JPEG WIDE, DNG+JPEG (RECT or WIDE)

Tap a format (JPEG RECT, or JPEG WIDE if available, or any DNG+JPEG format if available) to select it.

Tap the photo settings box again to close the sub-boxes and confirm your choice.



*Android photo formats: DNG+JPEG WIDE (zoom is locked, stream image is WIDE)*



*Android photo formats: DNG+JPEG RECT (zoom is unlocked, stream image is RECT)*

When you are happy with your settings and your framing, press the hard shutter button on the right of the **Parrot Skycontroller 3** (or tap the soft shutter button of the HUD) to take a photo.

In **"Single"** mode, the screen flashes white then freezes briefly in black and white to confirm a picture has been taken. The number to the left of the soft shutter button (the number of media on the microSD card) of the HUD is increased by 1.

In **"Burst"** mode, the screen flashes white then freezes briefly in black and white to confirm 14 pictures have been taken in the span of 1 second. The number to the left of the soft shutter button of the HUD is increased by 14.

In **"Bracketing"** mode, the screen flashes white then freezes briefly in black and white to confirm 3, 5 or 7 pictures have been taken. The number to the left of the soft shutter button of the HUD is increased by 3, 5 or 7, depending on your option choice.

In **"Timer"** mode, the countdown is displayed (from 3, 5 or 10 seconds) at the center of the HUD, the timer of the soft button also countdowns, then the screen flashes white and freezes briefly in black and white to confirm a picture has been taken. The timer of the soft shutter button resets. The number to the left of the soft shutter button of the HUD is increased by 1.

For additional details on the **"Panorama"** mode, refer to the next section, *"Creating Panoramas"*.

In **"Timelapse"** mode, the screen flashes white then freezes briefly in black and white to confirm a picture has been taken. 5 to 120 seconds later, depending on your option choice, the drone takes another photo, and so on until you press the shutter button again to stop the Timelapse. Between each shutter action, a green progress bar, at the bottom of the screen, serves as a countdown. At the end of the Timelapse, the number to the left of the soft shutter button reflects the total number of medias on the microSD card of the drone.



In "GPS Lapse" mode, the screen flashes white then freezes briefly in black and white to confirm a picture has been taken. Control and move ANAFI Thermal: when the drone reaches any point on a 5 to 200-meter bubble around the initial photo, depending on your option choice, the drone takes another photo, and so on until you press the shutter button again to stop the GPS Lapse. Between each shutter action, a green progress bar, at the bottom of the HUD, lets you estimate the distance the drone must cover before the next shot. At the end of the GPS Lapse, the number to the left of the soft shutter button reflects the total number of medias on the microSD card of the drone.

#### About ANAFI Thermal photo formats:

**JPEG RECT:** 4:3 aspect ratio, up to 16MP and 75.5° horizontal field of view (HFOV)

**JPEG WIDE:** 4:3 aspect ratio, 21MP, 84° HFOV - zoom is disabled for this format

**DNG+JPEG:** 4:3 aspect ratio, 21MP, 84° HFOV - zoom is disabled for WIDE option

- ⚠ The DNG+JPEG options produces at least 2 files (1 DNG, 1 JPEG) for each shutter action. As other RAW picture formats, DNG is a very useful format for professional photography processing and workflow. Indeed, RAW formats retain all the information gathered by photography sensors, contrary to JPEG formats - which are compressed and processed renderings of this comprehensive information. In consequence, RAW pictures such as ANAFI Thermal's DNG are heavy files, but they offer the very best post-processing and retouching possibilities.

#### Creating Panoramas

ANAFI Thermal panoramas are generated automatically through the gallery of FreeFlight 6, based on a series of pictures taken by the drone.

The generation of a panorama, regardless of its format, implies three phases:

- collecting the pictures, in flight;
- downloading the pictures from ANAFI Thermal to your device;
- stitching the pictures together to create the panorama, on your device, through the gallery of FreeFlight 6.

#### ⚠ Before shooting a panorama:

- Make sure you are not flying lower than 10 meters (30ft) over water.
- Make sure no object nor subject are present in a 10 meters (30ft) radius around ANAFI Thermal.
- Bear in mind ANAFI Thermal locks the exposure (refer to the "AE Lock" section of this guide for additional information on exposure locking) of the frame with which you start your panorama. For this reason, Parrot recommends you always frame the main subject of the intended panorama before pressing the shutter button.
- Bear in mind ANAFI Thermal will not enable you to proceed with a panorama if the drone is short on power (capturing a 360 Panorama takes ANAFI Thermal up to 3 minutes).

To capture a panorama, select the “Panorama” box from the “Photo Mode” menu of the HUD. Then, tap the panorama type you want to select it: **Vertical**, **Horizontal** or **360**. The soft shutter button icon reflects your choice, as on the screen capture below.

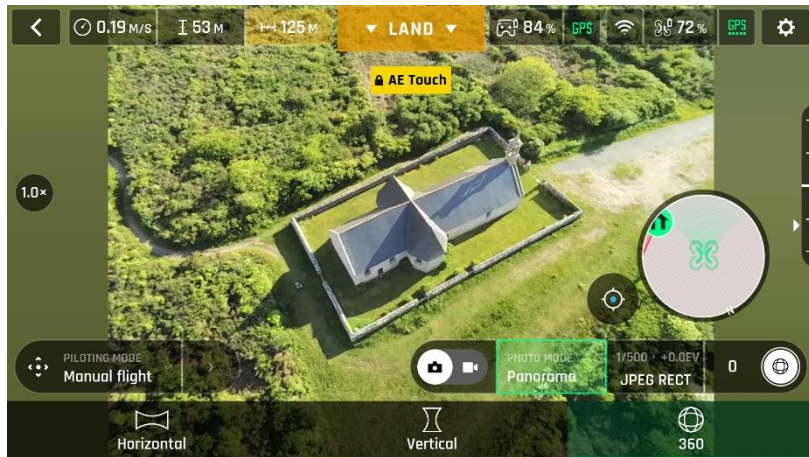

*Android Panorama types*

When you are happy with your framing, press the hard shutter button on the right of the **Parrot Skycontroller 3** (or tap the soft shutter button of the HUD) to begin the Panorama capture. **ANAFI Thermal** starts taking pictures and the bottom of the HUD displays a progress bar which fills with green as the capture unfolds.

### ⚠️ Panorama types capture characteristics:

- **Vertical:** **ANAFI Thermal** takes 8 photos in about 35 seconds
- **Horizontal:** **ANAFI Thermal** takes 10 photos in about 40 seconds
- **360:** **ANAFI Thermal** takes 42 photos in about 180 seconds (3 minutes)

To download the Panorama pictures to your device, land **ANAFI Thermal**, access the homepage of **FreeFlight 6** and tap the **microSD card box** or the **Gallery box** to display the media present on your microSD card. Like other media, Panoramas are marked with their distinct icon and a green download box, which shows the size of the corresponding series of pictures.

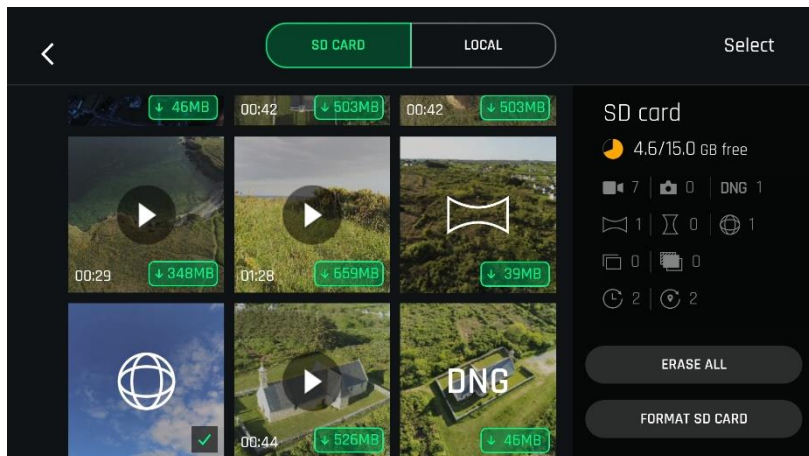

*Android microSD gallery: a 360 panorama has been downloaded to the device*

Tap the green box of the Panorama you want to generate to start downloading the corresponding series of pictures to your device. When the download is complete, **FreeFlight 6** displays a page from where you can delete the downloaded photos: tap "Yes" to keep the originals on the microSD card; tap "No" to delete them. **FreeFlight 6** displays the Local (device) gallery, which contains only the media you have downloaded from **ANAFI Thermal's** microSD card.

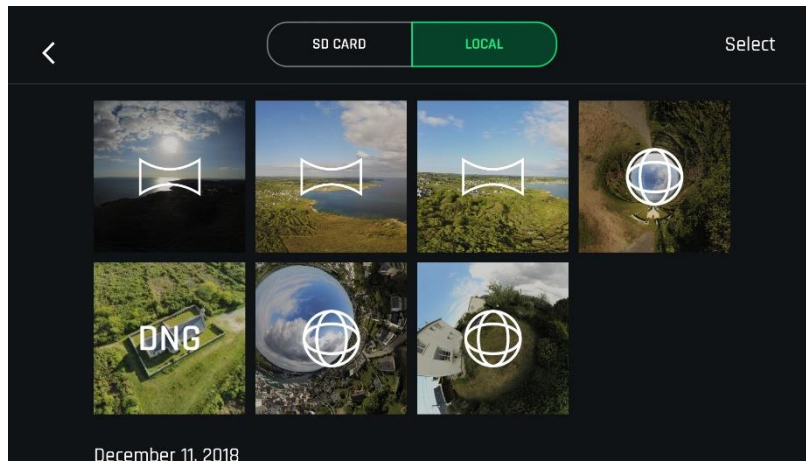

*Android Local (device) gallery*

Finally, select the panorama you want to generate from your Local gallery: **FreeFlight 6** displays the following screen.

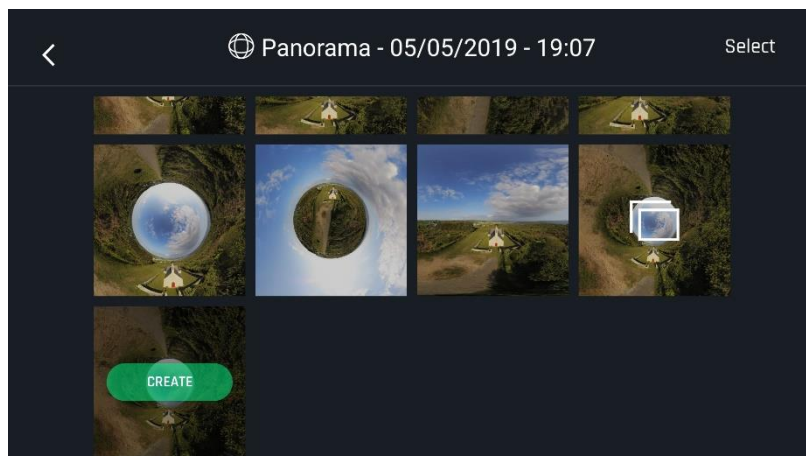

*Android Local (device) panorama generation page*

Tap "Create" to generate the panorama (or tap the other icon to access the series of individual pictures).

Depending on the power of your device, **FreeFlight 6** may display one or two resolution options, up to 32 MP. Select the option you want to launch the generation. The time this process takes also depends on your device's power. For the highest quality 360 panorama (32 MP), it can take several minutes.

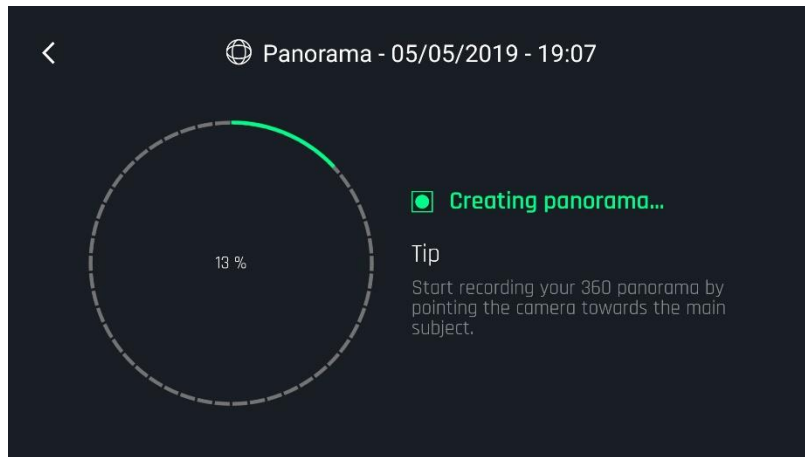

*Android: Creating panorama*

When the panorama creation is complete, **FreeFlight 6** displays the panorama and gives you the option to delete the original files.

- ⚠ For each **Vertical** or **Horizontal** panorama capture, you will be able to generate one panorama only.
- ⚠ For each **360** capture, you will be able to generate three different preset panoramas (**Sphere**, **Little Planet** and **Tunnel**) and a potentially infinite number of custom panoramas, through the 360 editor.
- ⚠ Do not worry about stitching issues on your 360 editor screen, when you create a custom panorama: the direct rendering is a preview only. For each custom panorama you decide to create, **FreeFlight 6** completely reprocesses the data to minimize stitching issues and discrepancies.



*An example of custom panorama*



## GIMBAL TILT AND ZOOM CONTROLS

Two of ANAFI Thermal's main assets are its gimbal tilt control capabilities (180°, from the ground to the sky), and its zoom. This section presents these features and the way to activate them.

### Gimbal tilt control

ANAFI Thermal's gimbal tilt control is activated through the left trigger of Parrot Skycontroller 3. It is available in all video and photo modes, and in all manual piloting modes.

- To aim the gimbal toward the ground, push the tilt control trigger down.
- To aim the gimbal toward the sky, pull the tilt control trigger up.
- To reset the gimbal tilt to a horizontal position, press the optics reset button on the left of Parrot Skycontroller 3 (this action also resets the zoom factor of the lens to x1).

### Zoom control

ANAFI Thermal's zoom control is activated through the right trigger of Parrot Skycontroller 3. It is available in all video modes, and in JPEG RECT photo mode (with an impact on the final resolution of your pictures). WIDE photo modes imply the use and rendering of all 21MP delivered by ANAFI Thermal's CMOS sensor: zoom is deactivated in both WIDE photo modes.

- To zoom in on a subject, push the zoom trigger down.
- To zoom out, pull the zoom trigger up.
- Pressing the optics reset button on the left of Parrot Skycontroller 3 instantly resets the zoom factor of the lens to x1 (this action also resets the gimbal tilt to a horizontal position).

The HUD of FreeFlight 6 presents precise, decimal-by-decimal zoom information at all times, in the middle of the left side of the screen, as shown on the following screen captures - note that in these examples, ANAFI Thermal's gimbal is tilted all the way toward the ground.

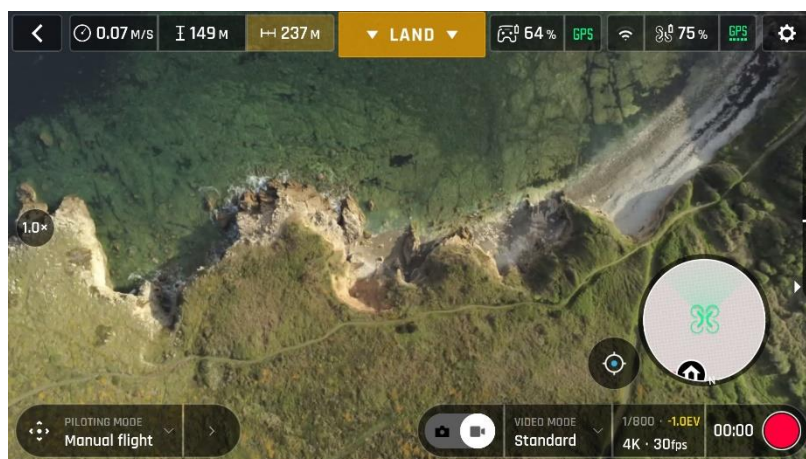

Android 4K x1 zoom

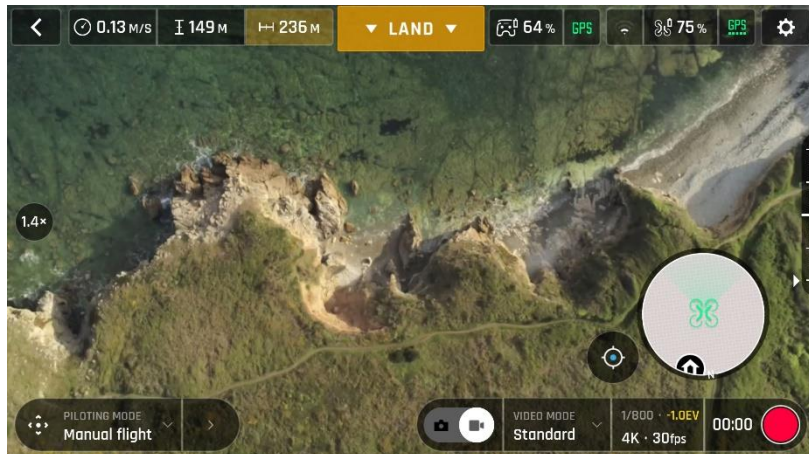

*Android 4K x1.4 zoom*

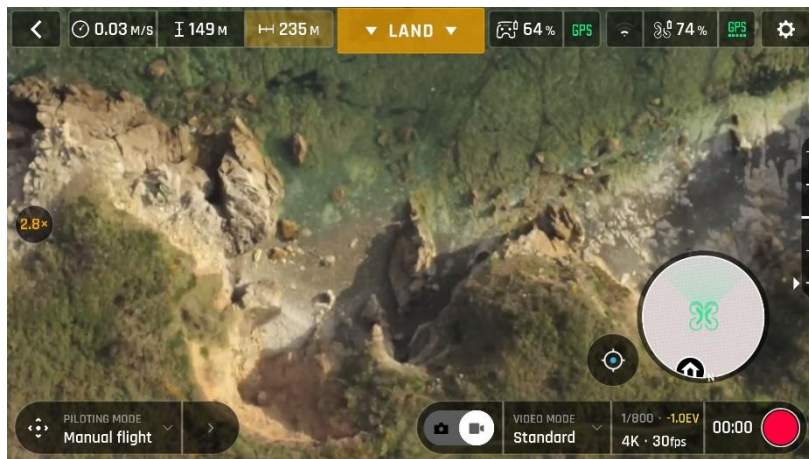

*Android 4K x2.8 zoom*

As already mentioned, **ANAFI Thermal** presents no lossless zoom capabilities for pictures: the zoom is deactivated by design in WIDE formats (JPEG and DNG+JPEG), and it has an impact on the resolution of the pictures in JPEG RECT format.

By contrast, **ANAFI Thermal** offers impressive lossless zoom capabilities for 4K UHD (x1.4), 2.7K (x1.9) and 1080p (X2.8) videos.



*iOS 1080p x1 zoom*

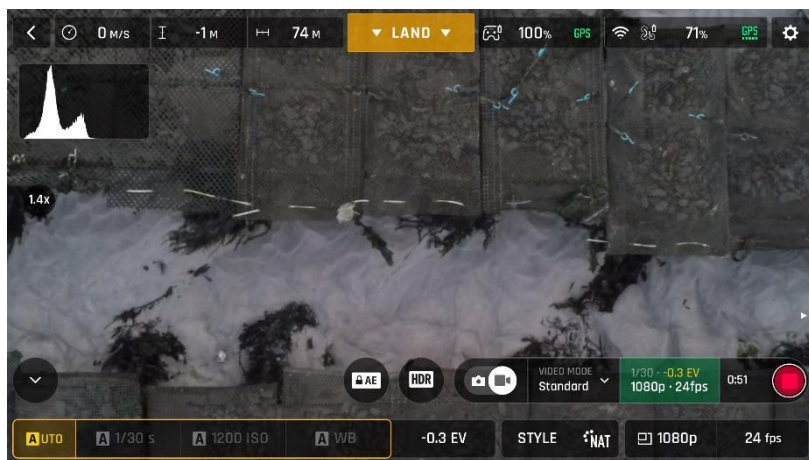

*iOS 1080p x1.8 zoom*

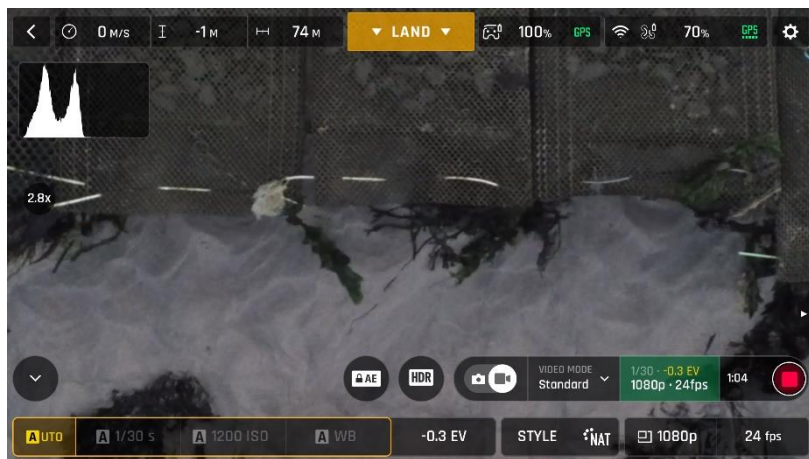

*iOS 1080p x2.8 zoom*

Note that in the video mode, when you leave the lossless envelope of the zoom, the zoom indicator, on the middle left of the HUD, turns orange instead of white.



## Camera Calibration: Correct horizon (exceptional procedure)

- ⚠ **Your ANAFI Thermal's camera has been factory-calibrated with unparalleled precision.** Unlike the calibration of ANAFI Thermal or that of the Parrot Skycontroller 3, which must be carried out periodically, **the camera calibration must not be carried out unless it appears necessary** – typically, after a crash. If you notice **a tilted horizon on all your videos and photos**, and if this **tilt is always on the same side**, access camera calibration to make your horizon perfectly straight again.

This feature is accessible from the **ANAFI Thermal** box on the **FreeFlight 6** homepage (or from the **ANAFI Thermal** box of the HUD) and from the *"PREFERENCE - Camera"* menu.

Before starting this procedure, you need to position **ANAFI Thermal** on a flat and perfectly level surface, exactly perpendicular to any pattern containing straight lines you can use as horizon references. A set square can help you check that a line on your floor is perpendicular to your wall, as on the following pictures.



*Finding a line perpendicular to the wall*



*ANAFI Thermal ready for camera calibration*



When **ANAFI Thermal** is correctly positioned, perpendicular to its straight horizon reference, power it on, along with the **Parrot Skycontroller 3** and your device, as you would for any flight.

Access "Camera calibration" from the **ANAFI Thermal** box of the homepage or the HUD of **FreeFlight 6**, or from the "PREFERENCES-Camera" menu.

Select the "Correct horizon" option from the following screen.

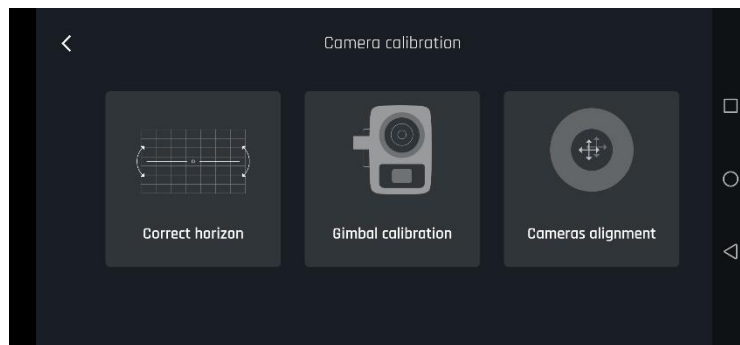

*ANAFI Thermal: Camera calibration (Android)*

The following screen appears.

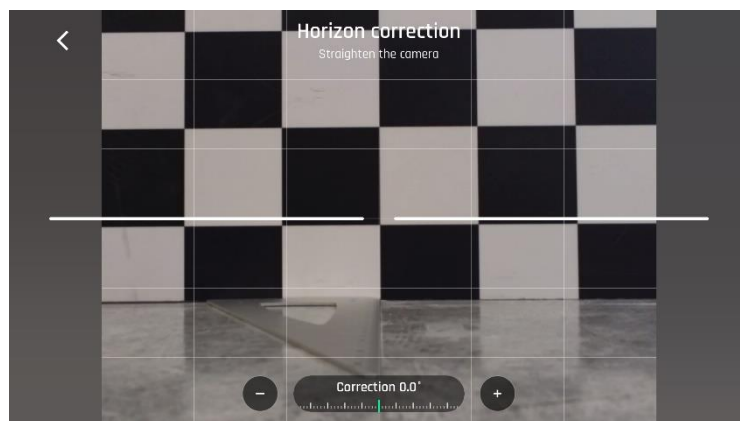

*Horizon correction: before (iOS)*

Tap "-" or "+" until the artificial horizon of **ANAFI Thermal** matches the horizon reference facing the drone. **Do not worry about vertical lines: they may not appear straight or parallel on the calibration screen.**

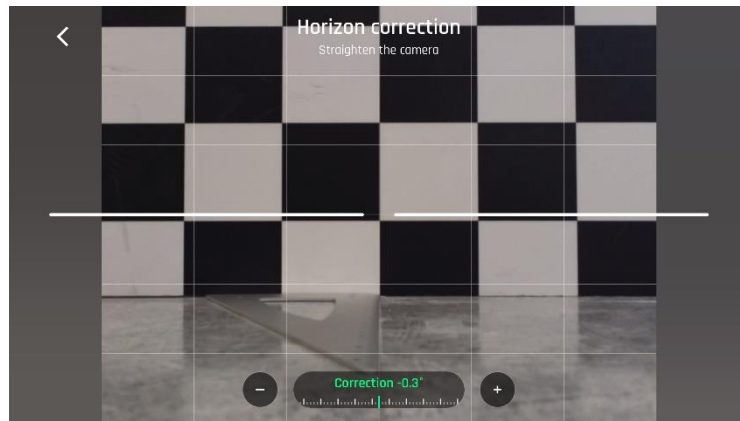

*Horizon correction: after (iOS)*

When you have straightened the tilt of the camera, tap the "<" icon on the top left of the screen to confirm your setting and exit camera calibration.

### Camera Calibration: Gimbal calibration

Use this option to perform a gimbal calibration, similar to that which occurs after **ANAFI Thermal** is powered on.

- ⚠ Be aware that **FreeFlight 6** can require you to carry out this procedure (as it can require you to perform a drone magnetometer calibration) before allowing you to fly **ANAFI Thermal**.

### Camera Calibration: Cameras alignment (exceptional procedure)

Use this option to align the images of your visible and thermal spectrum cameras.

As the interface advises, due to cameras parallax, use the farthest possible object as your alignment reference.

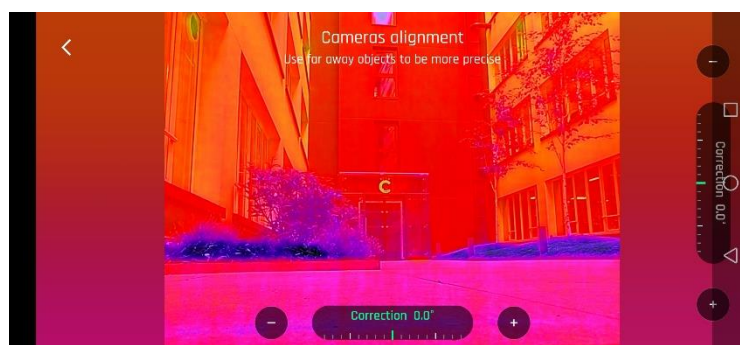

*ANAFI Thermal: Camera alignment (Android)*

Note that you can activate the zoom (right) trigger to magnify the view of your reference.

Tap “-” or “+” on each axis to align visible and thermal views - note that on these example screen captures, the alignment of the cameras does not need a correction.

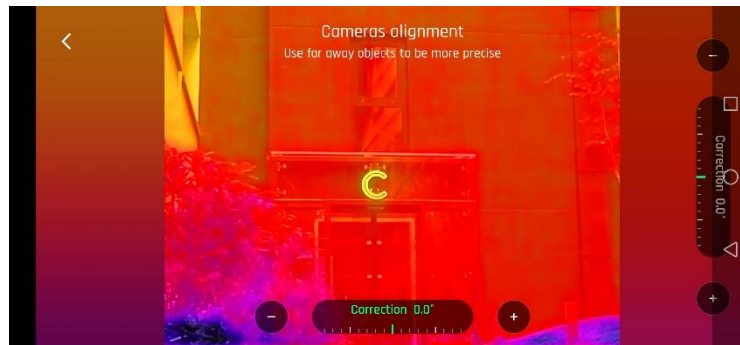

*ANAFI Thermal: Camera alignment, zoomed in (Android)*

Tap “<” on the top left of the screen to exit the interface and confirm your settings.

## PRO-IMAGING SETTINGS

ANAFI Thermal is set to deliver high quality and balanced 4K videos and 21MP photos, out of the box.

Some image enthusiasts and all professional directors, videographers and photographers, however, will find their way through pro-imaging settings. This section is designed to help you exploit manual settings and develop your filming and photography styles.

The Exposure value (EV) is the only setting accessible in the Auto mode, from the "Video/Photo settings box" menu of the HUD.

### Exposure value (EV)

The EV expresses the general darkness or lightness of a photograph – or a video. At +0.0 (zero) EV, **ANAFI Thermal** automatically adapts the shutter speed and the ISO value to deliver a perfectly balanced photo or video: not too dark and not too light.

Tap the "+0.0 EV" box to activate the EV slider.

Slide your finger on the screen to adapt your EV toward negative values and darken your picture or video.

Use positive values to lighten your images. This can be useful if you want to capture a backlit scene and to fade surroundings in light.



*ISO -1.0 EV*



*ISO +1.0 EV*

To activate further settings, tap "Auto", on the far left of the Video/Photo settings box. The additional settings boxes are unlocked, they stand out in white and "Auto" has been replaced with "Pro".

### Shutter speed (s)

The "s" value refers to the time, in fraction of second, when the shutter stays open to capture a still picture: it is called exposure time.

In Auto mode, **ANAFI Thermal** selects the best shutter speed and ISO value couple, in real time, depending on the scene and available light. In consequence, selecting a shutter speed also deactivates the Auto ISO mode.

As **ANAFI Thermal**'s f/2.4 aperture lens lets a lot of light in, even compared to most professional SLR lenses, your drone can achieve very fast “s” values (down to 1/10000s) and capture very fast action. It can also be used for slow shots, up to 1 second for the photo mode.

Note that **ANAFI Thermal** can shoot pictures and videos when it is not flying. You can even hold it in your hand and use it as a premium stabilized 4K video and photo camera.

**Tap the “s” box to open the shutter slider.**

**Select a value to exit the auto-mode for shutter speed and ISO. This action also deactivates the EV slider.**

**Set the s value you require, then tap the “ISO” box to select an ISO value.** Experiment! The display of the HUD reflects your settings. If you get lost, tap Auto either on the “s” or the “ISO” slider to get back to auto exposure and reactivate the EV slider.

### ISO value (ISO)

The ISO value refers to the sensitivity of the sensor. As we have seen, it is linked to the shutter speed value: both sliders activate when you deactivate the “Auto” mode and set a value for one, or for the other. The lower the ISO value, the lower the sensitivity of the sensor, and the lower the image noise (digital grain). Therefore, under good lighting conditions, such as sunny daylight outside shots, low ISO values (100 or 200) should always be selected. The sensitivity of the sensor increases as the ISO value goes up: 3200 ISO can be used to capture low light interior scenes, or exterior shots at dusk or dawn, for example.

By default, in Auto mode, **ANAFI Thermal** constantly adapts its ISO and shutter speed values to the scene it is filming. Setting an ISO value for a whole shot or series of shot, however, is very useful to professional filming.

**Tap the ISO box to open the shutter slider.**

**Select a value to exit the Auto mode for ISO and shutter speed. This action also deactivates the EV slider.**

**Set the ISO value you require, then tap the “s” box to select a shutter value.** Experiment! The display of the HUD reflects your settings. If you get lost, tap Auto either on the “s” or the “ISO” slider to get back to auto exposure and reactivate the EV slider.

### White balance (WB)

White balance deals with the color temperature of the light. Cold lights make the whites look blue. Warm lights make the whites look yellow. By default, in Auto WB mode, **ANAFI Thermal** keeps the whites white, at all times: it adapts its WB value in real time.

However, setting a WB value for an entire shot is especially useful for professional filming: stable WB facilitates the grading (color treatment) of videos.

Tap the WB box to open the white balance options.

Select the WB preset that is best suited for your shooting conditions, your subject, or both - or tap the CUSTOM option to set the temperature of the light of your scene manually, between 2 000 and 10 000 K (kelvins).

The display of the HUD reflects your settings and helps you make the best choice.



*Auto WB, Android*



*Incandescent WB, Android*



*Fluorescent WB, Android*



*Sunny WB, Android*



*Cloudy WB, Android*



*Shaded WB, Android*



*2 000 K WB, Android*



*10 000 K WB, Android*



## HDR

HDR (high dynamic range) is another great way to enhance a video or a photo. **The HDR option is available for Standard video mode 4K, 2.7K and 1080p formats** (regardless of framerate values) and **JPEG photos**.

To activate the HDR option, select a Standard video mode or a JPEG photo format from the relevant boxes of the bottom bar of the HUD. A white and round HDR icon appears on the screen of your device, to the left of the photo/video trigger.

Tap this icon: it turns yellow and an HDR notice appears in black inside a yellow box, under the "next available action" box, at the center of the top bar of the HUD. Press the hard shutter button on your **Parrot Skycontroller 3** (or the soft shutter button of the HUD) to start filming in HDR or to take an HDR photo.

Tap the round HDR icon again to deactivate HDR. The yellow HDR box disappears from the screen.



*iOS HDR off*



*iOS HDR on*

- ⚠ Note that you cannot modify "s", "ISO" or "WB" values when the HDR mode is activated. However, you always keep control over your EV value.
- ⚠ Note that activating (or deactivating) HDR stops any ongoing video recording.

## NATURAL Style

The **Natural Style** is the default **ANAFI Thermal Style**: it respects nature's colors and tones.

Activate the "NATURAL" Style from the "Style" box of the Video/Photo settings menu.

## P-LOG Style

One alternative Style to Natural looking images (default value) can be selected for **ANAFI Thermal** both in the video mode, and in the photo mode. This alternative Style is called "**P-LOG**". It makes images a little less contrasted: P-LOG style is ideal for videos you want to edit and process using professional grading tools and filters.

Activate the "P-LOG" Style from the "Style" box of the Video/Photo settings menu.

## INTENSE Style

Another alternative Style to Natural looking images (default value) can be selected for **ANAFI Thermal** both in the video mode, and in the photo mode. It is called "**Intense**". It makes images more saturated and contrasted.

Activate the "INTENSE" Style from the "Style" box of the Video/Photo settings menu.

## PASTEL Style

Another alternative Style to Natural looking images (default value) can be selected for **ANAFI Thermal** both in the video mode, and in the photo mode. It is called "Pastel". It makes images less saturated, but it brings out their warmest tones.

Activate the "PASTEL" Style from the "Style" box of the Video/Photo settings menu.

## ADJUSTMENT

The ADJUSTMENT button, to the right of the PASTEL box, provides three additional settings for your **Normal Style** still images and films:

- Saturation: sets the intensity of the colors (from -2 to +2)
- Contrast: sets the degree of difference between lighter and darker parts of the image (from -2 to +2)
- Sharpness: sets the distinction of the reproduction of details (from -1 to +1)



*All settings at minimal values (iOS)*

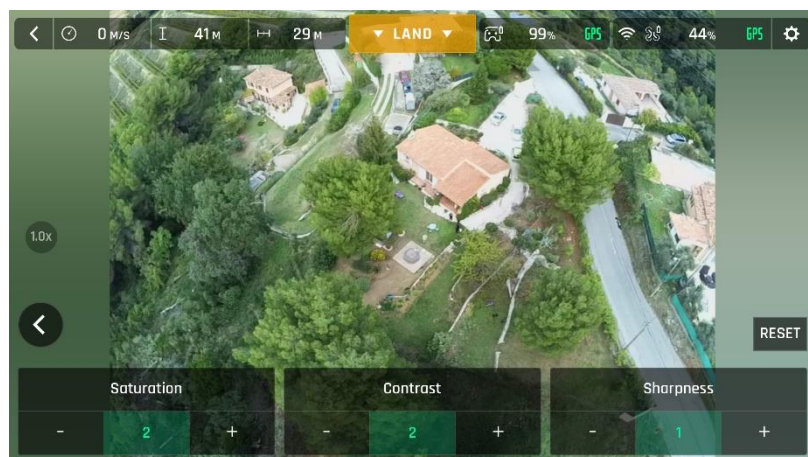

*All settings at maximal values (iOS)*

Tap the RESET button, on the right of the screen, to bring all values to 0 (zero).

Tap the "<" icon, on the left of the screen, to confirm your settings and exit the ADJUSTMENT menu.



## Lock AE

Another great feature of **FreeFlight 6** is the possibility to lock the general exposure of a view, to fine-tune the framing of a shot and keep the desired exposure.

To access this function, tap the “Video settings box” (video mode) or the “Photo settings box” (photo mode) of the HUD.

A “Lock AE” icon appears, to the left of the HDR icon (it replaces the “HDR” icon in DNG+JPEG photo format, since HDR is not available with this setting).

**Tap the “Lock AE” icon to lock the exposure value to that of the current view.** The icon turns to yellow. A yellow “Lock AE” box appears under the “Next available action” box, at the center of the top bar of the HUD.

Move **ANAFI Thermal** around or tilt its gimbal to change the frame: the exposure settings remain as they were when you activated the function.

**Tap the “Lock AE” icon again to deactivate the exposure lock:** the icon turns back to white and the yellow “Lock AE” box disappears.

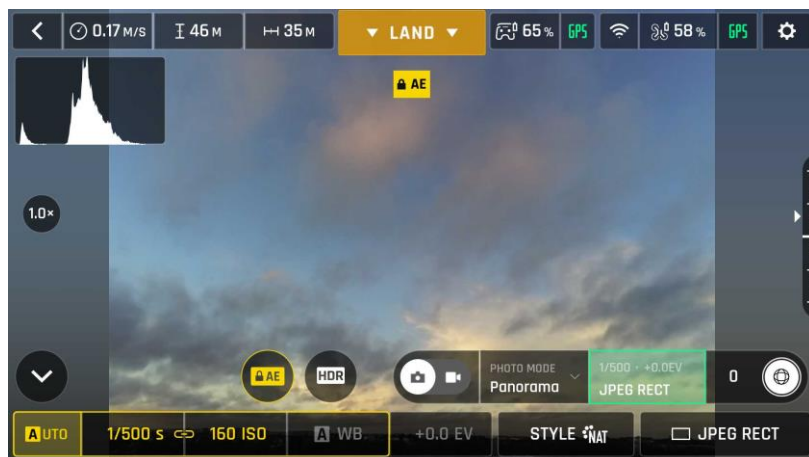

*Exposure is locked on the sky (Android)*

## Lock AE Touch

With the “Lock AE Touch” (or “Spot AE”) function of FreeFlight 6, you can also lock the exposure of a frame on any detail of any view.

To activate this function, follow the “Lock AE” procedure of the preceding section. When the exposure is locked, touch the part of the frame you want to base your exposure on. A yellow square animates around this spot and the yellow “Lock AE” box is replaced by a yellow “Lock AE Touch” box.

Refer to the following screen captures for additional details on the logic of this great feature.

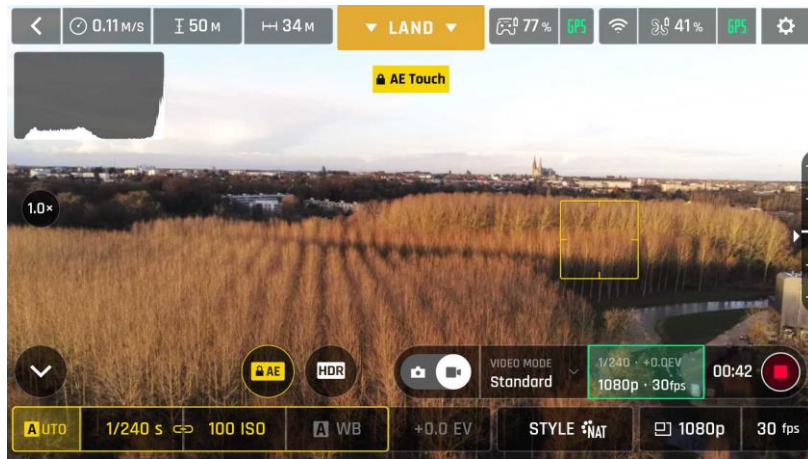

*Exposure is locked on the top of the trees (Android); shutter speed is set at 1/240 s*

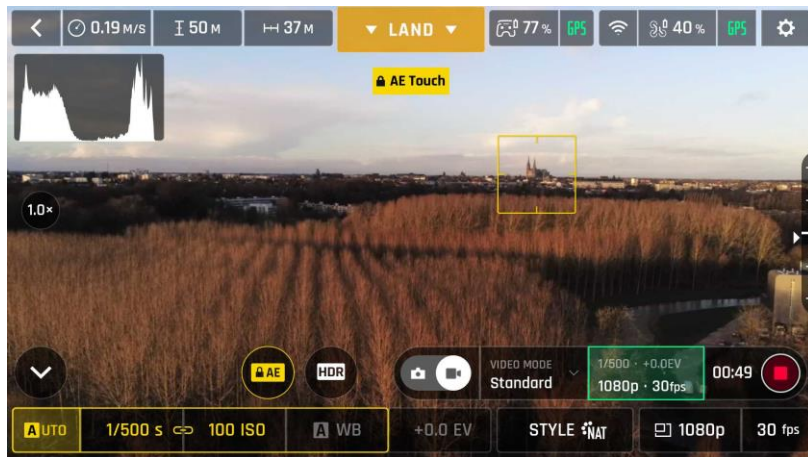

*Exposure is locked on a building on the horizon (Android); shutter speed is set at 1/500 s*

## THERMAL IMAGING

### About Thermal Imaging

Thermal imaging – or infrared (IR) thermography – is the process of acquiring, measuring and analyzing thermal information from non-contact devices, such as **ANAFI Thermal's** FLIR Lepton 3.5 camera.

Thermal imaging devices transform invisible IR radiations, or heat transfers, into colored images the human eye can interpret and analyze.

To access **ANAFI Thermal's** thermography mode, either tap the “THERMAL” box on the homepage of **FreeFlight 6** or tap the “SPECTRUM” box on the lower bar of the HUD and select “Thermal”.

### Presentation of the Thermal HUD

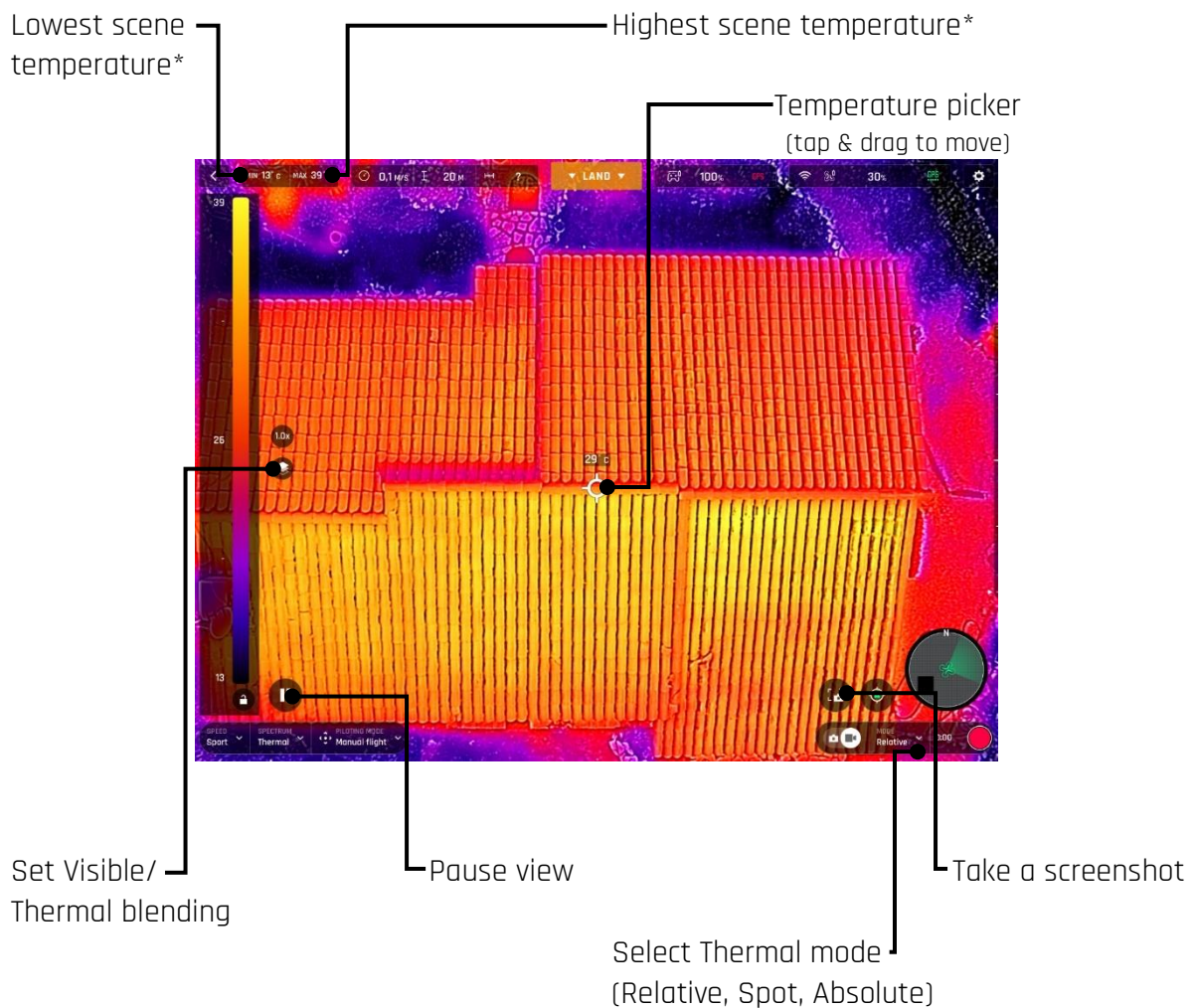

*\* Note that depending on your device (tablet or phone) and OS (iOS or Android), lowest and highest scene temperatures can be displayed on the right part of the screen, under the “PREFERENCES” icon.*

- ⚠ Note the “**Pause view**” button enables you modify your settings through the “PREFERENCES” icon, on the far right of the top HUD bar: exiting the PREFERENCES menu brings you back to the “paused view”. This is especially useful, for example, when you want to change your settings for a precise inspection.

As for the Visible Spectrum, you can record both **Thermal photos and videos**: make your choice through the photo/video toggle button in the lower bar of the HUD.

When in Thermal Spectrum, **the choice of photo modes is limited to three options**, each of which delivering 3264x2448 rectilinear JPEG thermography images:

- Single shot
- Timelapse (10, 30, 60, 120 or 240 seconds intervals between shots)
- GPS Lapse (5, 10, 20, 50, 100 or 200 meters spherical intervals between shots)

Remember that all thermography pictures taken by **ANAFI Thermal** can be analyzed and processed into a report with the free version of *FLIR Tools* ® (smartphone app and desktop software).

The **Thermal Spectrum video mode is limited to a single option**: **ANAFI Thermal** shoots 9 frames per second 1440x1080 thermography MP4 (H264) videos.

Tap and drag the **temperature picker**, at any moment, to obtain a direct temperature reading on any point of the central area of the screen – the part which is free from boxes or icons.

Finally, note you can always **capture screenshots**, directly to your device, through the dedicated screen button. This feature is especially useful when filming, as it enables you to extract a still image from a film without stopping the recording.

- ⚠ **ANAFI Thermal** is a double camera system. However, photo or video mode selection is independent from the cameras. In other words, for example, switching from Visible Spectrum photo mode calls the last Thermal Spectrum photo mode that was selected; similarly, switching from Thermal Spectrum video mode calls the last Visible Spectrum video mode that was selected.

### Relative Thermal mode

The Relative mode is the default thermography mode of **ANAFI Thermal**, which is activated upon first access to the Thermal HUD.

The Relative mode is useful to get a quick overview of any scene's temperature range. In this mode, even slight heat differences materialize as strong contrasts.

Its main specificity is that the scale it displays, on the left of the HUD, matches by default the temperature range of the scene **ANAFI Thermal** is filming.



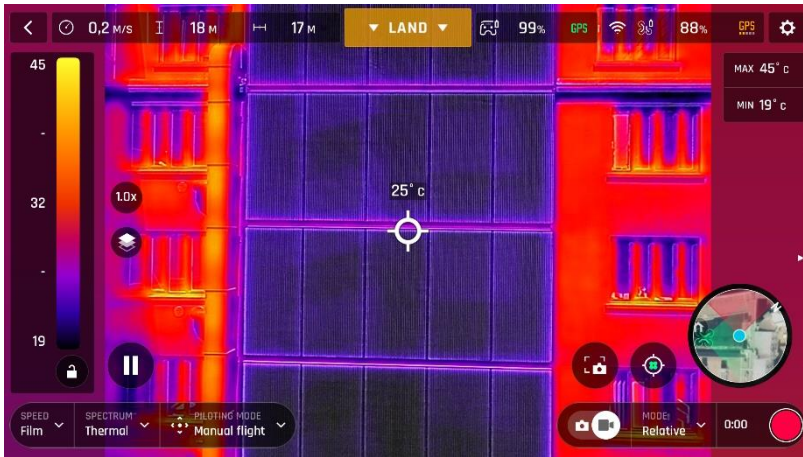

*Relative Thermal mode:  
reference image*

However, the **lock button** (under the scale, on the left of the screen) enables you to temporarily lock the scale to the temperature range of any scene. This is especially useful if you must reframe your scene to include part of the sky. Indeed, the sky always appears as a very cold element, which disturbs the scale.

Refer to the two following screenshots to compare locked (green lock icon) and unlocked (white lock icon) scales and color readings with the reference image.

*Temperature scale has been locked on reference image (19 to 46° C); the colors of the building are kept, although the gimbal has been reoriented toward the sky and clouds (which appear in grey and black - out of the scale).*



*Temperature scale has not been locked from reference image; the scale has adapted to the new scene (- 50 to 42° C), the colors of the building now lack contrast, but the clouds and sky have been colored.*

## Spot Thermal mode

The Spot Thermal mode of ANAFI Thermal is especially useful to isolate cold or hot spots.

Use the **inverted arrows button** (under the scale, on the left of the screen) to toggle from hot to cold (or from cold to hot) and **slide your finger along the scale** to adapt the threshold of the scale to your scene and highlight only coldest or hottest spots.

*Spot Thermal mode: only the hottest elements of the scene are colored.*

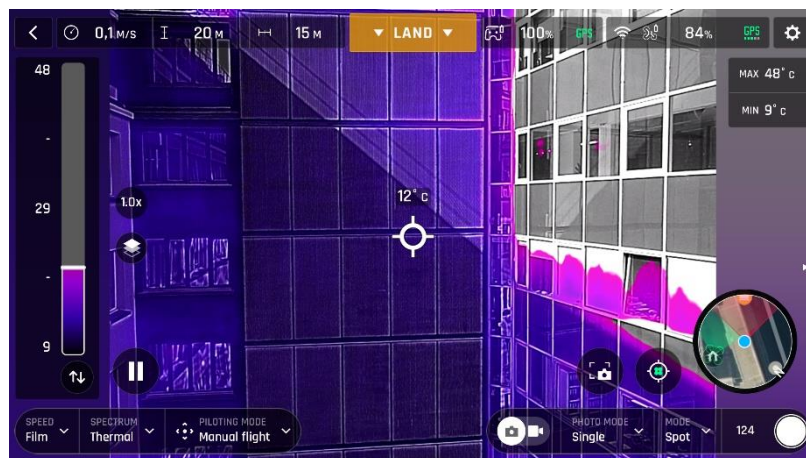
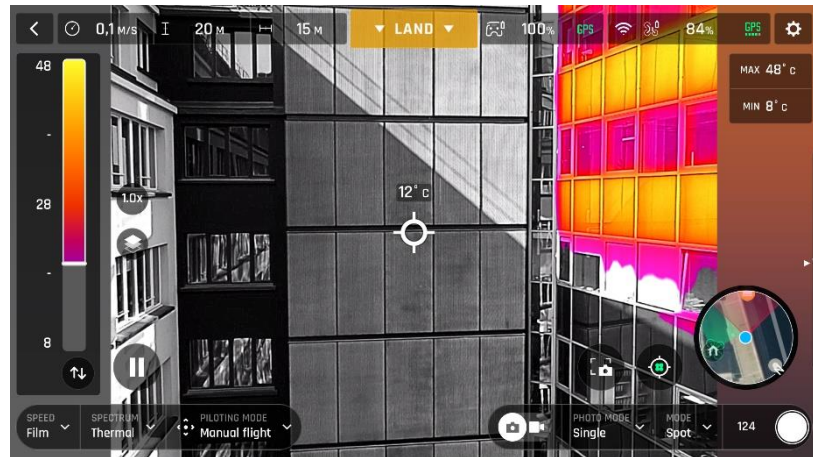

*Spot Thermal mode: the double arrow button has been activated from earlier screenshot: only the coldest elements of the scene are colored.*

Note that in Spot Thermal mode, as in Absolute Thermal mode, the thresholds you set manually are only reset when you tap the "RESET THERMAL SETTINGS" button in the Thermal Preferences tab.

## Absolute Thermal mode

The Absolute Thermal Mode is the most versatile of ANAFI Thermal's thermography modes. It enables the user to select a custom temperature scale and to focus on it, to achieve extremely precise color readings. Control your analysis through the two buttons located under the temperature scale.

On the left, the **double arrow button** toggles from narrow scale (0 to 50° C) to extended scale (- 10 to 140° C in DEFAULT range and - 10 to 400° C in VERY HIGH TEMPERATURE range; set range through PREFERENCES).

On the right, the **show/hide toggle** enables you to color only the part of the scale **you** have selected with the top and bottom white scale sliders.

Refer to the following screenshots for additional details on the features associated to these buttons.

*Absolute Thermal mode:  
note the lack of contrast of  
the image - double arrow  
button is set on narrow  
scale but the scale has the  
entire range colored.*

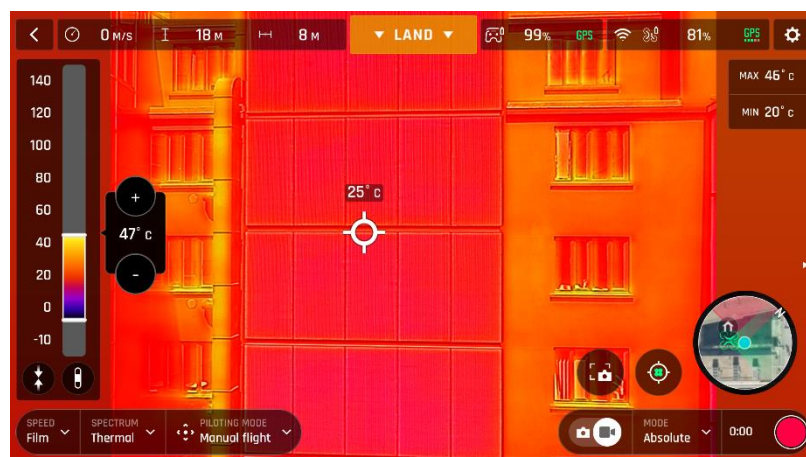
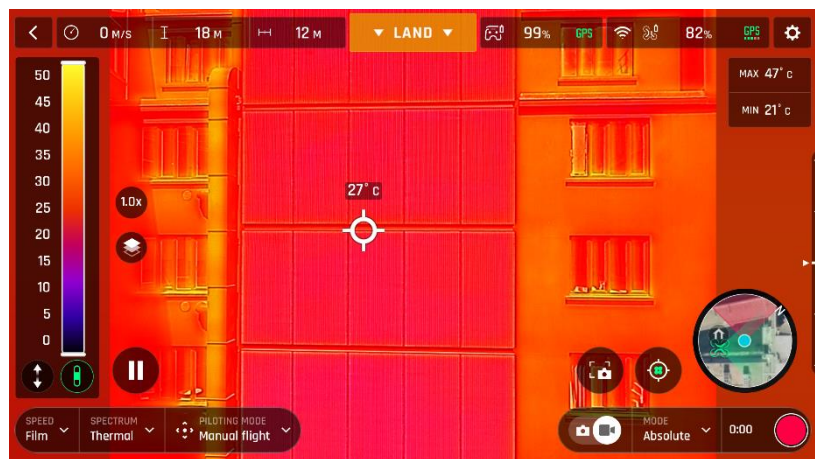

*Both buttons have been  
activated: extended scale is  
showing, but only selected  
range is colored. Contrast is  
still very low.*



*The selected range has been narrowed, from the bottom: the contrast of the image highlights the whole scale of temperatures of the scene, from blue (17° C) to yellow (45° C) through purple, red and orange.*

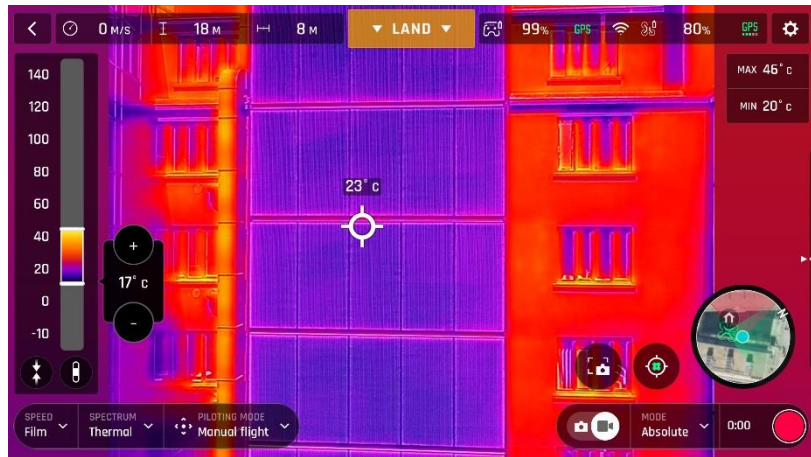

*The camera has been reoriented toward the sky. The selected scale is still locked. The colder and distant sky and clouds are excluded from color readings.*

Note that in Absolute Thermal mode, as in Spot Thermal mode, the thresholds you set manually are only reset when you tap the "RESET THERMAL SETTINGS" button in the Thermal Preferences tab.



## THERMAL ANALYZER MODE (DISPLAY OR REPLAY)

The Thermal analyzer feature of **FreeFlight 6** provides you with a great tool to achieve quick thermal analysis, directly from your device.

This function gives you full control over the on-screen rendering of any thermography video or photo you have taken with **ANAFI Thermal**. From the analyzer, you can:

- access Thermal Preferences directly from the preview's Preferences icon, top right;
- navigate inside your thermography videos;
- use the temperature picker;
- modify the thermography modes (Relative, Spot, Absolute) and their associated thresholds and functions (lock scale, hot or cold spot, etc.) at any point of any video or on any photo;
- modify the blending between Visible and Thermal spectrums;
- save as many screenshots as you want.

However, Thermal analyzer videos cannot be saved or exported by **FreeFlight 6** – even if most devices enable you to record your screen.

To analyze a thermography media, access your **Local FreeFlight 6 Gallery** and open a thermal video preview or a photo.



*Thermography video preview (iOS)*

Tap the green "ANALYZE" box.

The photo displays or the video plays in Analyzer mode. As shown on the following screen captures (extracted from a video analysis), the interface gives you access to most options available for filming.



*Thermal analyzer interface, Relative mode (iOS)*



*Same image (hot) Spot mode (iOS)*



*Same image Absolute mode (iOS)*



*Same image (hot) Spot mode, Thermal spectrum only (iOS)*

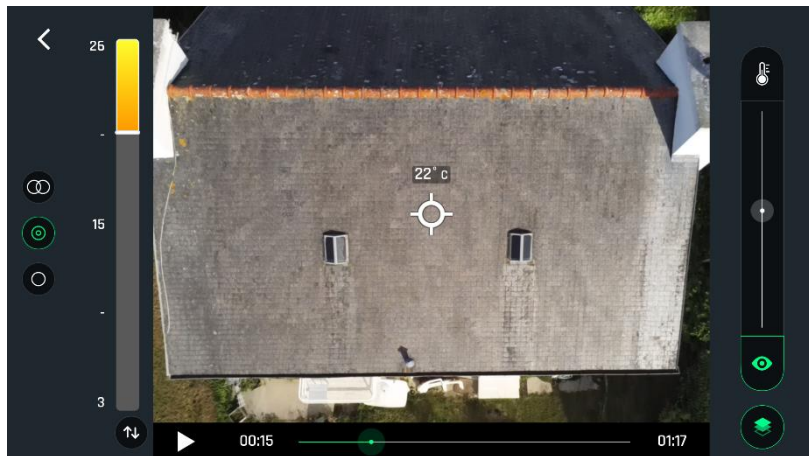

*Same image Visible spectrum only (iOS)*

## CINESHOTS (VISIBLE SPECTRUM ONLY)

ANAFI Thermal features a series of automated shots, which enable you to capture scenes professionally.

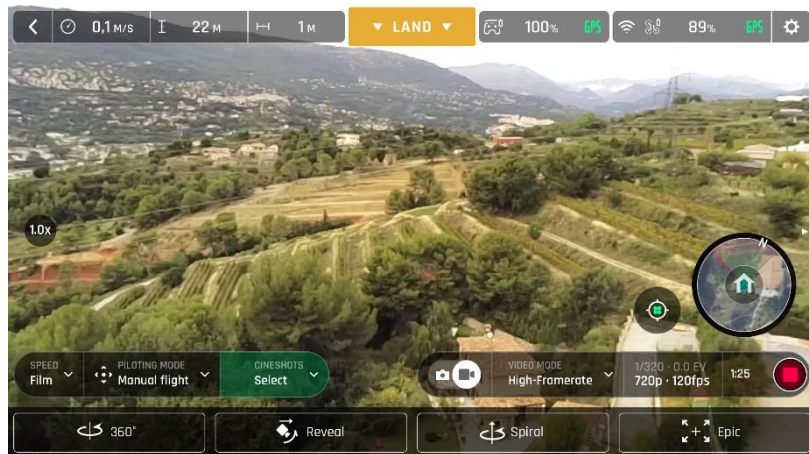

*iOS Cineshots Menu*

Make sure you have selected the video settings you require, check that you are filming and tap "CINESHOTS" in the bottom bar of the HUD to access Cineshots. Tap a Cineshot to select it. For each, two options appear.

### 360°

The 360° Cineshot is self-explanatory: when it is activated, **ANAFI Thermal** maintains its position and altitude, and rotates slowly and completely around its axis to uncover a full panorama.

Tap "Right" or "Left" to select the direction you want your drone to rotate, and to activate the 360°. After a countdown on the HUD, **ANAFI Thermal** starts its rotation. An animation flashes on the screen of your device, and the "360°" box progressively fills with green as the Cineshot unfolds.

### Reveal

The Reveal Cineshot is a classic motion picture opening shot: when it is activated, **ANAFI Thermal** tilts its camera toward the ground and starts moving forward in a straight horizontal line. Slowly, over 30 or 60 meters, the camera gimbal tilts up, revealing the scenery in front of **ANAFI Thermal**.

Before you activate the Reveal Cineshot, check the area in front of **ANAFI Thermal** is clear from obstacles, and safe.

Tap "30m" (small-arrow icon) or "60m" (large-arrow icon) to select the range of your Reveal shot, and activate it. After a countdown on the HUD, **ANAFI Thermal** tilts its camera down and starts moving forward. An animation flashes on the screen of your device, and the "Reveal" box progressively fills with green as the Cineshot unfolds.

## Spiral

The Spiral Cineshot is perfect to unveil your surroundings – or that of any object on the ground. When it is activated, **ANAFI Thermal** tilts its camera to the ground and starts moving up, in a straight vertical line. Slowly, as it climbs to 30 or 60 meters, **ANAFI Thermal** carries out a full 360° rotation around its axis, then and its camera tilts up progressively, panning over the scenery along a 180° rotation. Therefore, **ANAFI Thermal** finishes the Spiral Cineshot with a 180° angle, compared to its starting point.

**Before you activate the Spiral Cineshot, check the area beyond ANAFI Thermal is clear from obstacles, and safe: do not activate the Spiral Cineshot under trees, or a bridge, for example.**

**Tap “30m” (small-arrow icon) or “60m” (large-arrow icon) to select the range of your Spiral shot, and activate it.** After a countdown on the HUD, **ANAFI Thermal** tilts its camera down and starts moving up and rotating. An animation flashes on the screen of your device, and the “Spiral” box progressively fills with green as the Cineshot unfolds.

## Epic

The Epic Cineshot offers another great way to dramatize any scene or location. When it is activated, **ANAFI Thermal** moves away backward in a smooth ascending line, keeping its subject in the center of its frame for 30 or 60 meters. The Epic Cineshot gives best results when **ANAFI Thermal** starts from a close-up position, relative to its subject.

**Before you activate the Epic Cineshot, check the area behind ANAFI Thermal is clear from obstacles, and safe.**

**Tap “30m” (small-arrow icon) or “60m” (large-arrow icon) to select the range of your Epic shot, and activate it.** After a countdown on the HUD, **ANAFI Thermal** starts moving backward and upward. An animation flashes on the screen of your device, and the “Epic” box progressively fills with green as the Cineshot unfolds.

- ⚠ **Activate and monitor all Cineshots with care: always check your automated shot flight plan is clear from obstacles and safe, always retain visual contact with ANAFI Thermal, and always be ready to reclaim control of your drone: any action on any stick of Parrot Skycontroller 3 immediately terminates the current Cineshot.**



## PILOTING MODES

Tap the “PILOTING MODE” box in the bottom bar of the HUD of **FreeFlight 6** to access the piloting modes options.

Tap a mode to select it. Each mode is associated with a specific behavior, which this section describes.

### Manual flight

The Manual flight mode is **ANAFI Thermal**'s default mode. It enables you to pilot the drone and fully control its camera tilt and zoom.

When you release the commands in Manual flight mode, **ANAFI Thermal** stays in position, hovering.

### Cameraman (visible spectrum only)

The Cameraman mode enables you to keep an object or a subject in the center of your frame, while you pilot **ANAFI Thermal** around it/him/her.

Frame the object or subject you want to film and fly around.

Tap the “PILOTING MODE” box in the bottom bar of the HUD to access the options. Tap “Cameraman” to select this piloting mode.

Draw a rectangle with your finger on the screen of your device, around the object or subject you want **ANAFI Thermal** to follow – or double tap this object or subject. When your target is locked, the blue rectangle turns to green and the orange “LAND” box at the center of the top bar of the HUD turns red and displays “STOP”. **ANAFI Thermal**'s frame centers on your target, inside the green box.

Drag the green box to the area of the frame where you want your target to remain at.

Fly **ANAFI Thermal** around your target. The drone keeps your target in the part of the frame you have selected. Therefore, if you push the right joystick of the **Parrot Skycontroller 3** to the left, **ANAFI Thermal** circles around your target clockwise. If you push the right joystick of the **Parrot Skycontroller 3** to the right, **ANAFI Thermal** circles around your target counterclockwise.

When the Cameraman mode is activated, **ANAFI Thermal** manages the gimbal tilt to keep the target in the frame. Therefore, the left trigger of the **Parrot Skycontroller 3** is deactivated in this mode. However, you can still control the zoom, with the right trigger.

When you release the commands in the Cameraman mode, **ANAFI Thermal** hovers and rotates to keep following the target.

To end the following of your target, tap the red "STOP" box at the center of the top bar of the HUD.

When no target is selected, or when the following of the target has been ended by the pilot, **ANAFI Thermal**'s behavior is similar to that of the Manual flight mode.

- ⚠ **Activate and monitor the Cameraman mode with care: always check your flight plan and the trajectory of your subject are clear from obstacles and safe, always retain visual contact with the drone, and always be ready to stop the following (tap the "STOP" box of your HUD) in case a danger or any sort of unexpected obstacle arises.**

### Follow Me (visible spectrum only)

The Follow Me mode was designed to enable **ANAFI Thermal** pilots to have their drone follow them in action.

Fly **ANAFI Thermal** at least 5 meters (15ft) high and 10 meters (30ft) in front of you, facing you – **FreeFlight 6** will inform you with a red alert at the bottom of the HUD if you are too close from **ANAFI Thermal** or if it is flying too low. Frame yourself.

Tap the "PILOTING MODE" box in the bottom bar of the HUD to access the options. Tap "Follow Me" to select this piloting mode.

Both a drone GPS synchronization and a device GPS synchronization are imperative to activate this mode: upon first activation, the following page appears.

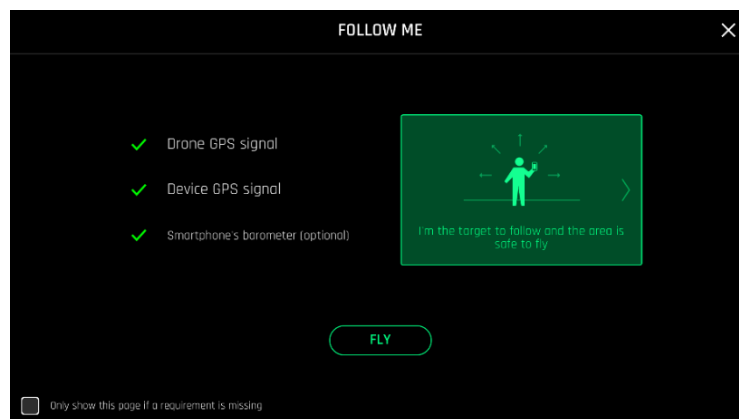

*iOS, Follow Me GPS warning*

Tick the box on the bottom left on the page if you do not want this warning to appear again when no prerequisite is missing. Tap "FLY" to access the Follow Me mode.

Select one of the three Follow Me options (refer to in-app tutorials for details):

- Track
- Lock
- Dynamic (**Parrot recommends you only use this option in completely open and unobstructed areas**)



Draw a rectangle with your finger on the screen of your device, around yourself. When **ANAFI Thermal** has a lock on you, the blue rectangle turns to green and the orange “LAND” box at the center of the top bar of the HUD turns red and displays “STOP”.

By default, **ANAFI Thermal** keeps you in the center of the frame, but you can drag the green box to the area of the screen you want to remain at. If you push the right joystick of the **Parrot Skycontroller 3** to the left, **ANAFI Thermal** circles around you clockwise. If you push the right joystick of the **Parrot Skycontroller 3** to the right, **ANAFI Thermal** circles around you counterclockwise.

In the Follow Me mode, **ANAFI Thermal** manages the gimbal tilt to keep you in the center of the frame. Therefore, the left trigger of the **Parrot Skycontroller 3** is deactivated in this mode. However, you can still control the zoom, with the right trigger.

When you release the commands in the Follow Me mode, **ANAFI Thermal** keeps following you from a constant distance if you are moving. If you stay immobile, **ANAFI Thermal** stops and stays focused on you.

To have **ANAFI Thermal** stop tracking you, tap the red “STOP” box at the center of the top bar of the HUD.

When no target is selected, or when the tracking has been ended by the pilot, **ANAFI Thermal**'s behavior is similar to that of the Manual flight mode.

In addition, the Follow Me mode features a series of exclusive Dronies which can be activated as you move, always keeping you in the center of the frame. For each Dronie, two options are available (they are listed between brackets):

- **Orbit (left or right):** **ANAFI Thermal** circles around you in a full 360°.
- **Parabola (10 or 30 m):** **ANAFI Thermal** flies in a circular arc over your head, gaining 10 or 30 meters in altitude and turning 180° at its peak.
- **Tornado (10 or 30 m):** **ANAFI Thermal** performs a double “Orbit” around you, one going up 10 or 30 meters, the other going down 10 or 30 meters, back to its original height.
- **Boomerang (30 or 60 m):** **ANAFI Thermal** flies away from you for 30 or 60 meters, with an ascending angle following that of the starting gimbal tilt, then comes back to its starting point.

To select a Follow Me Dronie, make sure you are in the Follow Me mode and that **ANAFI Thermal** is tracking you.

Tap the “Select Dronie” box in the bottom bar of the HUD.

Tap a Dronie to select it. Tap the option you have chosen to activate the Dronie: after 2 seconds, **ANAFI Thermal** starts moving around you. The corresponding Dronie box fills with green as the Dronie unfolds.

- ⚠ **Activate and monitor the Follow Me mode and each Dronie with care: always check your flight plan is clear from obstacles and safe, always retain visual contact with ANAFI Thermal, and always be ready to stop the following (tap the "STOP" box of your HUD) in case a danger of any sort or an unexpected obstacle arises.**
  
- ⚠ **To optimize the drone's tracking, always make sure you remain visible by ANAFI Thermal: do not let an obstacle obstruct the camera's view and do not hide in the shadows, or ANAFI Thermal could lose track of you.**

### Smartdrones (visible spectrum only)

**ANAFI Thermal** features four Smartdrones:

- the **Orbit**, **Parabola** and **Boomerang** Dronie can be accessed through this menu - refer to the above section for details about the **Boomerang** Dronie;
- however, the smartest of **ANAFI Thermal**'s drones is the **Dolly Zoom**.

We will not spoil it for you: just make sure you have a memorable scenery behind you. Frame yourself (or better yet, your group of friends!) with **ANAFI Thermal**: keep the drone at least 5 meters away, at man level, between 1 and 2 meters above the ground.

**Check that the flight path of your drone is perfectly clear: at least 30 meters behind it, flat and without obstacles.**

**Tap "Smartdrones" from the "PILOTING MODE" box menu.**

As for the Follow Me mode, both a drone GPS synchronization and a device GPS synchronization are imperative to activate this mode: upon first activation, the same warning page appears as for the Follow Me mode. Tick the box on the bottom left on the page if you do not want this warning to appear again when no prerequisite is missing. Tap "FLY" to access the Smartdrones mode.

**Tap the Dolly Zoom Dronie to open its three options: try them all and enjoy the magic!**

### FPV (visible spectrum only)

As any drone of the **ANAFI** series, **ANAFI Thermal** can be flown in FPV (first person view) mode, using the **Parrot Cockpitglasses 3** or any compatible FPV goggles.

Refer to the latest general **ANAFI** user guide for additional information on FPV immersive flying.

## MAP-BASED FLYING MODES

### Flight Plan

Flight Plan is a powerful tool, which enables you to fully prepare and configure your flights and filming sessions, from home, on the train, in a plane, or anywhere else you can take your phone with you.

Through an example, this section will teach you the basics of automated flight and shooting management, with ANAFI Thermal and Flight Plan.

Tap Flight Plan from the “PILOTING MODE” box menu. The map of your surroundings opens full screen. If you are not connected to ANAFI Thermal, the minimized live view is black, as on the screen captures that follow. Find your next dream flying spot on the map.

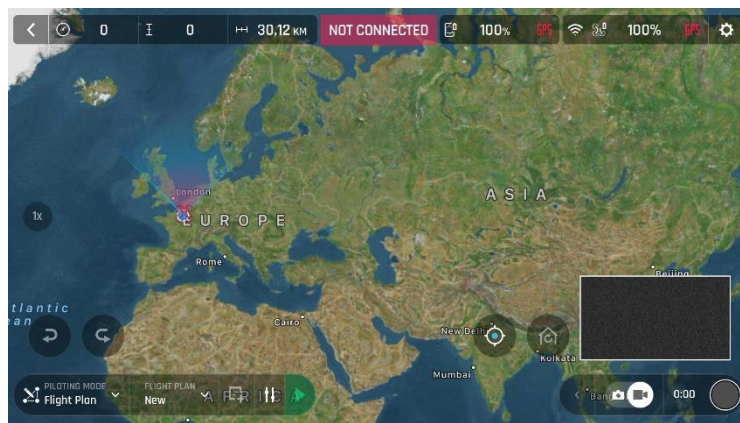

*iOS Flight Plan*

Consider this pointy bit of land, with a lighthouse in the middle. Say you could fly ANAFI Thermal and shoot a film there. Let's do it!

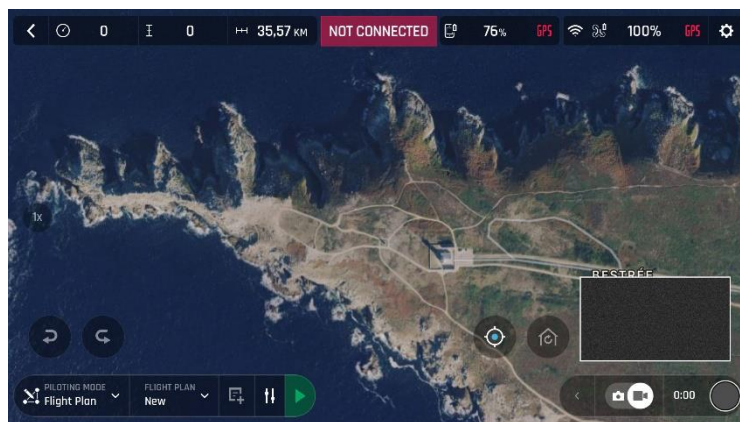

*iOS: new Flight Plan*

First, select your initial waypoint: ideally, very close to your intended take-off point. Tap the screen to set it. The green circle represents the waypoint, the white figure the altitude of the drone, and the white arrow the direction of the drone's camera.

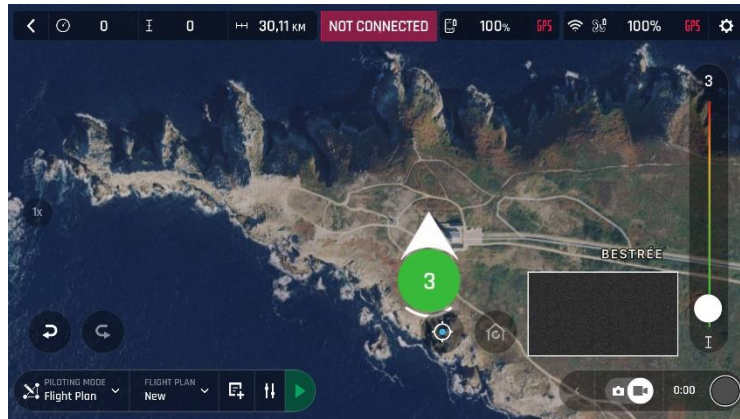

*iOS: initial waypoint*

Tap the white arrow and hold it to move it around. In this example, we want ANAFI Thermal to frame the lighthouse as it starts the flight.

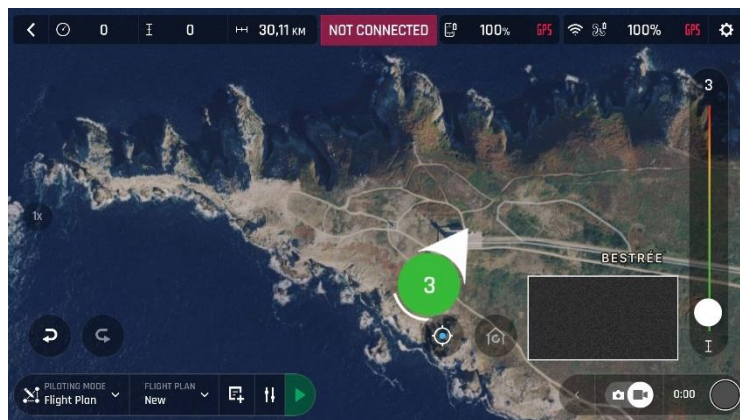

*iOS: initial waypoint, with the camera framing the lighthouse*

Tap the map to set the second waypoint: the distance between the two waypoints appears on the screen. Use the slider on the right of the screen to set the altitude of the waypoint.

In this example, **ANAFI Thermal** will climb from 3 to 30 meters between the initial waypoint and the second waypoint.

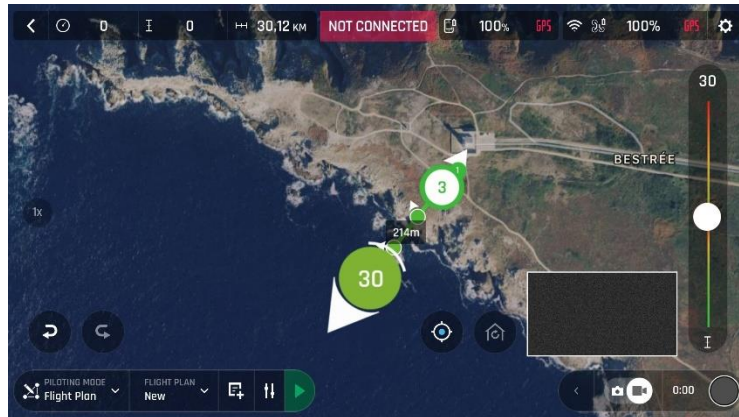

*iOS: second waypoint*

Add waypoints to tour the area and end your Flight Plan where you intend to land.



*iOS: full Flight Plan*

The tip of the peninsula is a POI: we want **ANAFI Thermal** to focus on it while it flies around it. **Tap it and hold your finger on the screen to call choices (POI/Close),**



*iOS: setting a POI*

**Tap "Point of interest" to add the POI.** It appears as a blue square diamond. The figure in the center represents the height of the POI, which you can modify using the slider



on the right of the screen. All waypoints turn white as they can now be selected to be linked to the POI.



*iOS: open waypoints*

Tap waypoints to link them to the POI. In this example, we want **ANAFI Thermal** to film the tip of the peninsula as it flies around it; we have selected the three waypoints to the left of the peninsula. The arrows of those waypoints have turned toward the POI and are colored in blue - the last one which was selected has a blue border around the white arrow.



*iOS: three waypoints linked to the POI*

Tap the POI to confirm your choices. Blue waypoints are linked to the POI, which appears as a white square diamond with a blue border. During the entire blue part of the flight, **ANAFI Thermal**'s camera will stay focused on the tip of the peninsula, enabling you to achieve the smoothest flyby shoot. Green waypoints remain independent from the POI.



*iOS: POI Flight Plan*

Tap a green waypoint to edit it: use the slider on the right of the screen to modify its height; tap and move its white arrow to set the direction of ANAFI Thermal's camera. For this example, we had the drone point toward the land at most steps of the Flight Plan, and toward the lighthouse at take-off and landing, with a descent from 30 to 3 meters between the last two waypoints.

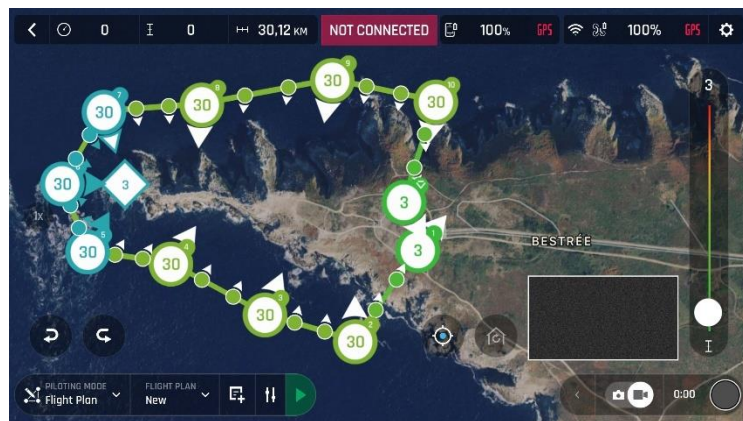

*iOS: POI Flight Plan*

All you have to do now is to close **FreeFlight 6**, to get to your flying spot, to prepare **ANAFI Thermal**, your **Parrot Skycontroller 3** and your device for the flight.

Tap the "PILOTING MODE" box on the HUD to call the options. Select "Flight Plan": the last plan you have set up appears.

Tap the green arrow on the right of the left bottom bar of the Flight Plan interface to begin the Flight Plan: ANAFI Thermal takes off, flies to the first waypoint and starts the Flight Plan. At the end of the Flight Plan, depending on your settings and depending on your version of FreeFlight 6, ANAFI Thermal lands at, or hovers over, the last waypoint you have set.



That is why, for this section, we have chosen to consider that **ANAFI Thermal's** final waypoint is also its landing spot.

- ⚠ **Activate and monitor every Flight Plan with extreme care: always check your drone's route is clear from obstacles and safe, always retain visual contact with ANAFI Thermal, and always be ready to stop the Flight Plan (tap the "STOP" box of your HUD or reclaim commands of the drone) in case a danger or any sort of unexpected obstacle arises.**

## Touch & Fly: Waypoint

Waypoint is the default “Touch & Fly” mode. It enables you to fly **ANAFI Thermal** to any point on the map. Tap “Touch & Fly” from the “PILOTING MODE” box menu.

The map of your surroundings opens full screen. The live image captured by **ANAFI Thermal** is minimized in the bottom right corner of your screen.

**Tap a point on the map to select a destination for ANAFI Thermal:** this point is marked as a white circle with an orange border, labelled with a flag icon. **ANAFI Thermal** immediately starts flying toward the selected point. Use the slider on the right of the screen to control the drone's altitude (the orange figure inside the circle) when it reaches its destination.

**⚠ Activate “Touch & Fly” Waypoint with care: be especially careful with your touches on the screen in this mode, as any tap on the map will immediately send ANAFI Thermal to the corresponding spot.**

For this reason, Parrot recommends you set your **FreeFlight 6** filming or photography options **before** activating the “Touch & Fly” Waypoint mode.

If, by mistake, you have sent **ANAFI Thermal** towards a dangerous area, tap the STOP box at the center of the top bar of the HUD, or firmly reclaim commands from the **Parrot Skycontroller 3**.



*iOS Touch & Fly: ANAFI Thermal flying to its destination*

## Touch & Fly: POI

To access the POI “Touch & Fly option”, tap the “Type” box from the lower bar of the HUD, and select POI.

In POI mode, tap a point on the map to create a point of interest (POI), marked as a white square diamond with a blue border, labelled with a POI icon. Control the height of the POI (the blue figure inside the square diamond) through the slider on the right:

this effectively controls the tilt of the gimbal, while you use the **Parrot Skycontroller 3** to fly around your target. **ANAFI Thermal** remains focused on the POI.

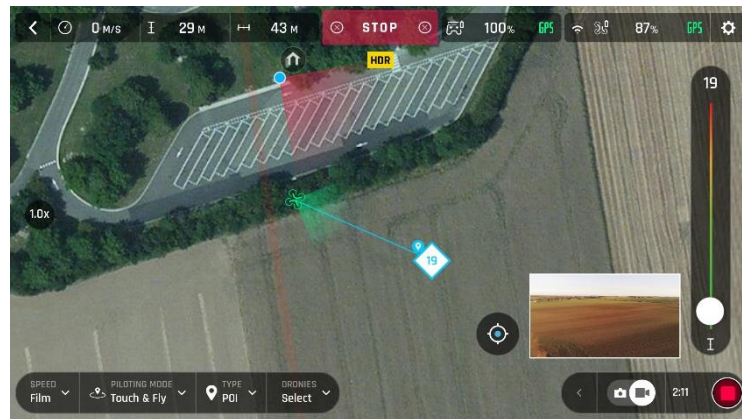

*iOS Touch & Fly; POI*

Tap "STOP" from the red box at the center of the top bar of your screen to halt **ANAFI Thermal**, or to reset a POI.

From the "Dronies" box, next to the "Type" box of the lower bar of the HUD, you can also shoot Dronies (**Orbit**, **Parabola**, **Dolly Zoom**, **Boomerang**) of your POI.

## APPENDIX 1: TROUBLESHOOTING GUIDE

This guide addresses all issues ANAFI Thermal users may have encountered while discovering and using a drone from the ANAFI Thermal series.

*DO NOT CONTACT PARROT SUPPORT before you have applied the procedures and tips relevant to your issue.*

### TROUBLESHOOTING PROCEDURES

#### ANAFI Thermal drone hard reset

Hard resetting ANAFI Thermal reverts ANAFI Thermal's most recent firmware to its original state. Parrot recommends the drone hard reset as a first intent procedure for several issues, notably gimbal calibration troubles.

1. Check a compatible microSD card is inserted into ANAFI Thermal.
2. Power **ANAFI Thermal** on (short press on the battery's power button).
3. Wait for the gimbal to calibrate (or for the gimbal calibration to fail).
4. Press and hold the battery's power button: after 8 seconds a battery's LED lights up in red.
5. Release the battery's power button: **ANAFI Thermal** powers off briefly then reboots.
6. Check the contents of **ANAFI Thermal**'s microSD card: the hard reset procedure has generated a .TXT document named "wifi\_security\_key" at the root of the microSD card. This document confirms the hard reset procedure is complete and successful.

#### ANAFI Thermal's smart battery hard reset

Hard resetting ANAFI Thermal's battery is useful to correct any battery issue. Parrot recommends a battery hard reset whenever the battery's behavior strays from its expected behavior.

1. Plug your smart battery to a power source.
2. Regardless of the battery's behavior, press and hold its power button for 15 seconds.
3. Release the power button: the battery's LED run successively in green and red, then flash alternatively in green.
4. The battery's hard reset is complete.

## Reboot all systems

Rebooting all systems is useful to solve connectivity issues (black screen, white noise, etc.).

1. Power **ANAFI Thermal** off.
2. Close the **Parrot Skycontroller 3**.
3. Kill **FreeFlight 6** on your device.
4. Reboot your device.
5. Open the **Parrot Skycontroller 3**.
6. Power **ANAFI Thermal** on.
7. Wait for synchronization between **Parrot Skycontroller 3** and **ANAFI Thermal** (steady dark blue LED on the controller); check that the left trigger of the **Parrot Skycontroller 3** activates the drone's gimbal to ensure the synch is complete.
8. Plug your device to the **Parrot Skycontroller 3**.

## Pairing ANAFI Thermal to a Parrot Skycontroller 3

This procedure is useful to pair a drone and a controller which have never been paired, and to restore the lost pairing between a drone and a controller.

1. Power **ANAFI Thermal** on.
2. Open the **Parrot Skycontroller 3** to power it on.
3. Plug the drone and the controller together with an USB-A (controller) to USB-C (drone) cable.
4. The LED of the **Parrot Skycontroller 3** flashes briefly in green: it is acknowledging **ANAFI Thermal**.
5. Wait for synchronization between **Parrot Skycontroller 3** and **ANAFI Thermal** (steady dark blue LED on the controller); check that the left trigger of the **Parrot Skycontroller 3** activates the drone's gimbal to ensure the synch is complete.
6. Unplug the controller from the drone.

## ISSUES

What do I do if I experience a connectivity issue (black screen, white noise, thermography camera activation failure, frozen or lagging stream)?

1. Check that your device's Wi-Fi is disabled: Parrot even recommends you set your device in Airplane mode when you fly **ANAFI Thermal**, to minimize the risks of communication disturbance.
2. **Reboot all systems** (refer to the relevant procedure in the earlier section of this guide).

### What do I do if my **ANAFI Thermal**'s gimbal does not calibrate?

**Hard reset ANAFI Thermal** (refer to the relevant procedure in the earlier section of this guide).

### What do I do if my **ANAFI Thermal** does not power on?

Make sure your smart battery is "awake": plug it to a power source to take it out of wintering mode, and its LED should start flashing to acknowledge the fact it is charging – Parrot recommends you always fully charge your smart battery before you fly **ANAFI Thermal**.

### What do I do if my battery shows a strange behavior (flashing LED, red LED, etc.)?

**Reset the smart battery** (refer to the relevant procedure in the earlier section of this document).

### What do I do if I cannot read properly the information displayed by **FreeFlight 6**?

1. Access the settings of your device.
2. Find the "Display / Text and display size" (or equivalent) options.
3. Turn down the "text size" of your device, its "display size", or both to let **FreeFlight 6** accommodate all its information on your screen.

### What do I do if my **ANAFI Thermal** is connected to the **Parrot Skycontroller 3**, but won't take off when I hit the take-off button?

1. If you had not done it, plug your device (in airplane mode, or at least Wi-Fi turned off) to your **Parrot Skycontroller 3**.
2. The drone or controller boxes of the homepage of **FreeFlight 6** either signal you that:
  - you must update your Parrot Skycontroller 3, your **ANAFI Thermal**, or both;
  - or you must calibrate your **ANAFI Thermal**'s gimbal;
  - or you must carry out a magnetometer (drone) calibration;
  - or you must calibrate your **Parrot Skycontroller 3**.

### What do I do if my **ANAFI Thermal** flips over at take-off?

The propeller blades have been improperly installed. Remove all propeller blades and reinstall them properly and carefully, following the instructions enclosed in all **ANAFI Thermal** propeller blades packs.

### What do I do if my **Parrot Skycontroller 3** does not synch with my **ANAFI Thermal**?

1. Check no device is connected on **ANAFI Thermal**'s Wi-Fi network, with **FreeFlight 6** running.
2. Pair your **ANAFI Thermal** to your **Parrot Skycontroller 3** (refer to the relevant procedure in the earlier section of this document).

### What do I do if my **Parrot Skycontroller 3** does not synch with my device?

1. Try connecting your **Parrot Skycontroller 3** and your device with a different cable, to eliminate the potential faulty cable issue.
2. When you have eliminated the faulty cable issue, and if you still cannot get the controller and device to synch, close your **Parrot Skycontroller 3** to turn it off.
3. Try connecting your device to your **ANAFI Thermal**'s Wi-Fi network and open **FreeFlight 6**.
4. If your device does not connect to **ANAFI Thermal**, try uninstalling **FreeFlight 6** and reinstalling it (WARNING: if you use an iOS terminal, remember to save your **FreeFlight 6** media on your device or on a computer, as uninstalling **FreeFlight 6** will delete all your media).
5. When your device and **ANAFI Thermal** are connected, plug your device to your **Parrot Skycontroller 3**.
6. After less than a minute, the full ecosystem connection (**FreeFlight 6** on the device, **Parrot Skycontroller 3**, **ANAFI Thermal**) should be restored.

*If the full connection is not restored, contact Parrot Support as your **Parrot Skycontroller 3**'s USB - A connector is probably damaged.*

### What do I do in the unlikely event my **ANAFI Thermal** has sustained a crash?

**⚠ FIRSTLY YOU MUST CHANGE ALL YOUR PROPELLER BLADES BEFORE ATTEMPTING ANOTHER FLIGHT; PROPELLER BLADES ARE INSTRUMENTAL FOR FLIGHT INTEGRITY AND DELICATE PIECES OF EQUIPMENT, AND EVEN "MINOR" CRASHES CAN INVISIBLY DAMAGE THEIR STRUCTURE.**

1. Set up **ANAFI Thermal** for a flight.
2. Check the **ANAFI Thermal** page of FreeFlight 6: any permanently damaged element (gimbal or motor) will appear in red - if an element is damaged, refer to point 8 below.
3. If no element is damaged, carry out the calibration(s) requested by FreeFlight 6 (gimbal, magnetometer, or both).
4. Fly **ANAFI Thermal** in a mission, take pictures and videos.
5. Check your **ANAFI Thermal** pictures and videos to see if your drone's horizon is offset.
6. If your horizon is offset, carry out the "Correct horizon" procedure (refer to **ANAFI Thermal**'s User Guide for details) of FreeFlight 6's "Camera" Preferences
7. If the "Correct horizon" function cannot make your horizon straight again, it means a part of your gimbal has been deformed and your drone needs service and a new calibration - refer to point 8 below.
8. Note that if the crash has damaged a component of **ANAFI Thermal** which is essential to a safe flight (such as its vertical camera or its ultra-sonar), your drone will not be able to take off and a FreeFlight 6 alert will tell you to contact your Parrot Support Partner. In this case, be ready to provide the Parrot Support Partner with:
  - a. the serial number of your **ANAFI Thermal**;
  - b. a proof of the purchase (invoice) of your **ANAFI Thermal**;
  - c. the full contents of your microSD card "FDR" folder.



## APPENDIX 2: OPERATIONAL CHECKLIST

This foolproof checklist has been developed with military ANAFI series drone pilots.

If it is useful to them, it is useful to every ANAFI Thermal pilot.

### Update & calibration

|                             |         |
|-----------------------------|---------|
| Device                      | UPDATED |
| FreeFlight 6                | UPDATED |
| Skycontroller 3             | UPDATED |
| ANAFI Thermal               | UPDATED |
| Magneto calibration         | OK      |
| Skycontroller 3 calibration | OK      |
| Gimbal calibration          | OK      |

### Skycontroller 3 & ANAFI Thermal OFF

|  |  |
|--|--|
| Arms   | unfolded, locked                         |
| Arms mechanical lash                           | NONE                                     |
| Lens cap                                       | OFF                                      |
| Check drone and gimbal                         | OK                                       |
| Check propellers                               | intact, free                             |
| Check <b>Skycontroller 3</b>                   | OK, 100 % charged                        |
| Check terminal to <b>Skycontroller 3</b> cable | OK                                       |
| <b>If terminal = tablet</b>                    | <b>Skycontroller 3 tablet holder: OK</b> |
| <b>ANAFI Thermal</b> battery                   | OK, 100% charged                         |
| <b>ANAFI Thermal</b> battery LED               | 4 x OK                                   |
| <b>ANAFI Thermal</b> battery temp              | OK                                       |
| Device   | OK, 100% charged                         |
| MicroSD card                                   | Inserted                                 |
| <b>ANAFI Thermal</b> battery                   | 3 hooks engaged in drone, locked         |

## Skycontroller 3 & ANAFI Thermal ON

|                                      |   |
|--------------------------------------|---|
| <b>Skycontroller 3</b> (SC3)         | open, ON, flashing light to dark blue LED               |
| <b>ANAFI Thermal</b>                 | ON, gimbal calibration OK                               |
| SC3 / ANAFI Thermal Wi-Fi connection | steady dark blue LED on SC3, L trigger moves gimbal: OK |
| Device                               | ON, Wi-Fi & Bluetooth OFF                               |
| Device / SC3 link                    | <b>FreeFlight 6</b> launched, image feed & telemetry:OK |
| Flight mode selection                | MANUAL  |
| RTH Height                           | set (20m to 100m)                                       |
| Max altitude                         | set   |
| Max distance                         | set   |
| Geofence                             | activated if needed                                     |
| Image settings                       | OK  |
| Check Stick Mode                     | Inverted / Special mode                                 |
| Map on app                           | OK  |
| Micro SD card                        | Formatted   |
| Battery levels                       | XXX% (report on flight log if ≠ from 100%)              |
| Global reactivity                    | set   |
| Camera tilt speed                    | set   |
| Inclination                          | set   |
| Vertical speed                       | set   |
| Rotation speed                       | set   |

### Before take-off

|                                 |                     |
|---------------------------------|---------------------|
| <b>ANAFI Thermal</b> GPS signal | Red / Orange /Green |
| Device GPS signal               | Red / Green         |
| Flight mode                     | MANUAL              |
| Weather                         | OK                  |
| TO Zone                         | Clear               |
| Drone status                    | Check               |
| Take-off/Land command           | Take-off            |

### After take-off

|                       |  |
|-----------------------|--|
| Precise Home Set      | Depending on conditions / 10 secs or 10 meters |
| Check Stick Mode      | Inverted / Special mode                        |
| Flight mode           | MANUAL   |
| Check flight commands | OK   |
| Check gimbal          | OK   |
| Video feed            | OK   |
| Video latency         | OK   |
| Drone status          | Check  |

### Before landing

|                       |        |
|-----------------------|--------|
| Flight mode           | MANUAL |
| Weather               | OK     |
| Landing Zone          | Clear  |
| Drone status          | Check  |
| Take-off/Land command | Land   |

### After landing

|                                   |                            |
|-----------------------------------|----------------------------|
| Check engines off                 | OK                         |
| Drone status                      | Check                      |
| <b>ANAFI Thermal Battery</b>      | OFF                        |
| <b>Skycontroller 3</b>            | Closed, OFF                |
| Check drone / gimbal / propellers | OK                         |
| Lens cap                          | ON                         |
| <b>ANAFI Thermal Battery</b>      | Disengaged, stored away    |
| Micro SD card                     | Stored away                |
| <b>ANAFI Thermal arms</b>         | Folded, no mechanical lash |
| <b>ANAFI Thermal drone</b>        | Stored away                |
| Device                            | OFF / Stored away          |
| <b>Skycontroller 3</b>            | Stored away                |
| Cables                            | Stored away                |

### Documents

|                         |                      |
|-------------------------|----------------------|
| Flight & batteries info | Report on flight log |
|-------------------------|----------------------|

*If you have feedback or comments about the v6.7.0.1 of this user guide, please reach out to:*

[technical.writer@parrot.com](mailto:technical.writer@parrot.com)